

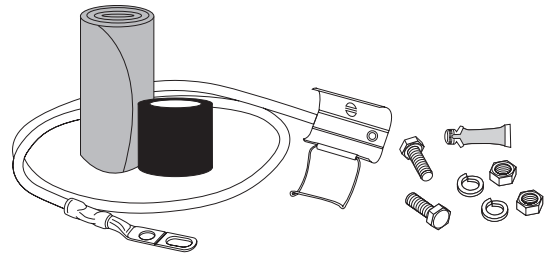

Installation Instructions

SureGround™ Grounding Kits for Coaxial Cables

Andrew Institute offers installation training.

Cable size	Part number	Tool part number	Description
1/2"	SG12-06B2A	GKT-L4SG	Grounding kit stripping tool for corrugated 1/2" cable
1/2"	SG12-12B2U		
7/8"	SG78-06B2A	GKT-78SG	Grounding kit stripping tool for corrugated 7/8" cable
7/8"	SG78-12B2U		
1 1/4"	SG114-06B2A	GKT-114SG	Grounding kit stripping tool for corrugated 1 1/4" cable
1 1/4"	SG114-12B2U		
1 5/8"	SG158-06B2A	GKT-158SG	Grounding kit stripping tool for corrugated 1 5/8" cable
1 5/8"	SG158-12B2U		



WARNING  Do not attempt grounding kit installation in the presence of thunderstorms. Failure to obey this warning may result in injury or death to you or to others.

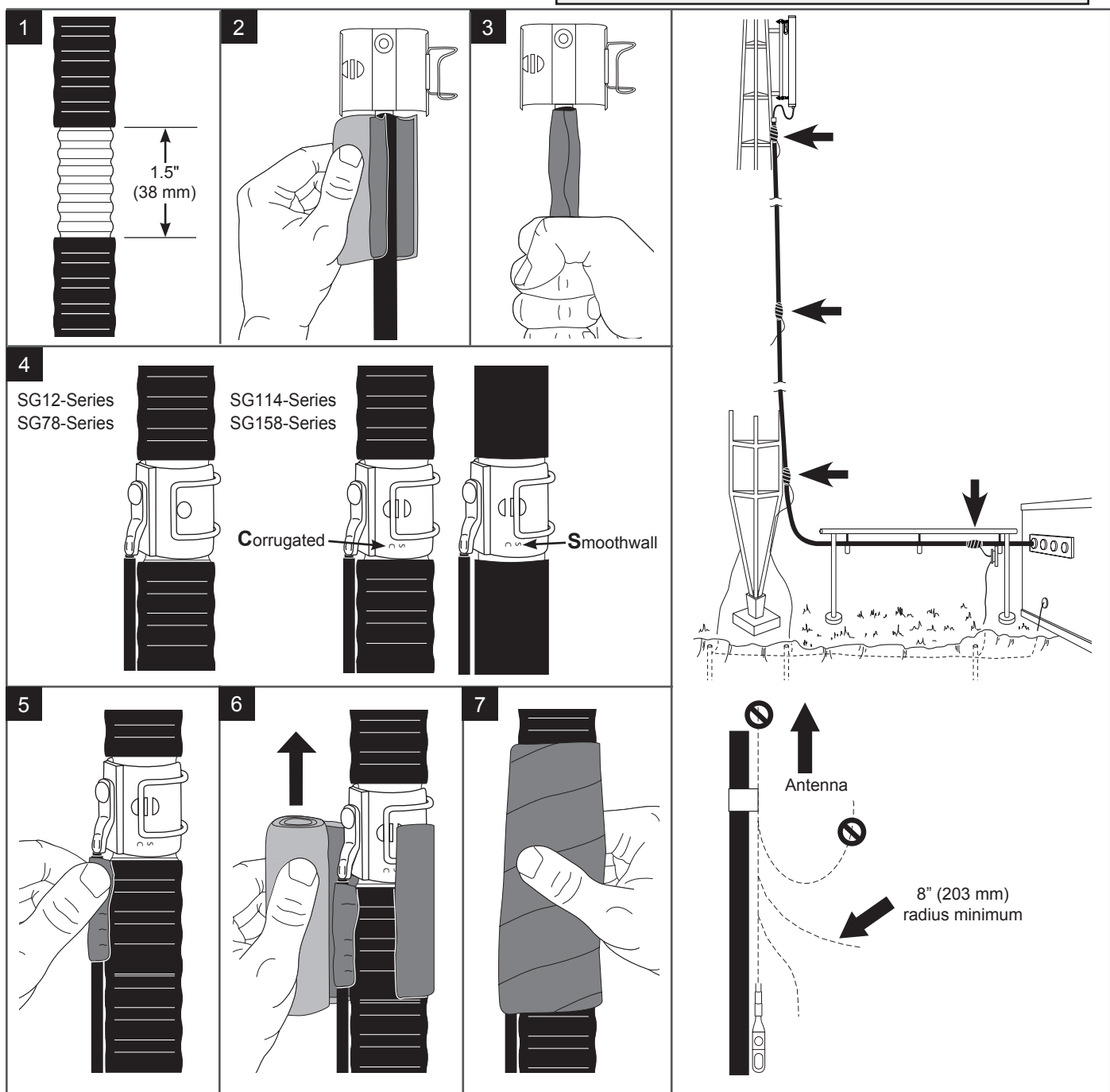

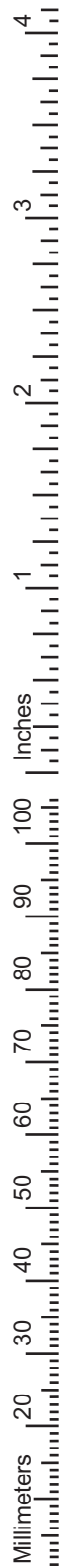
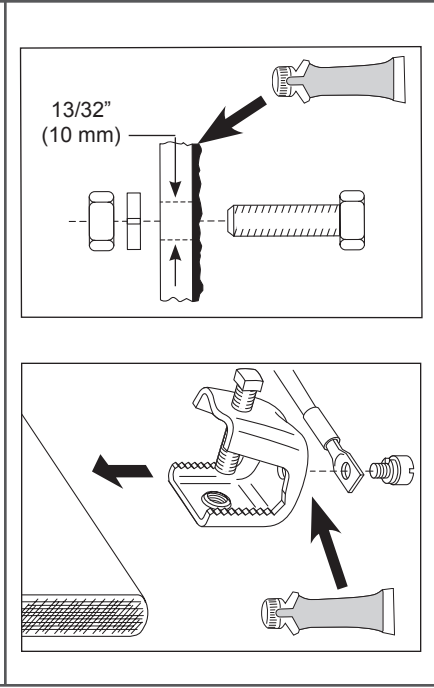
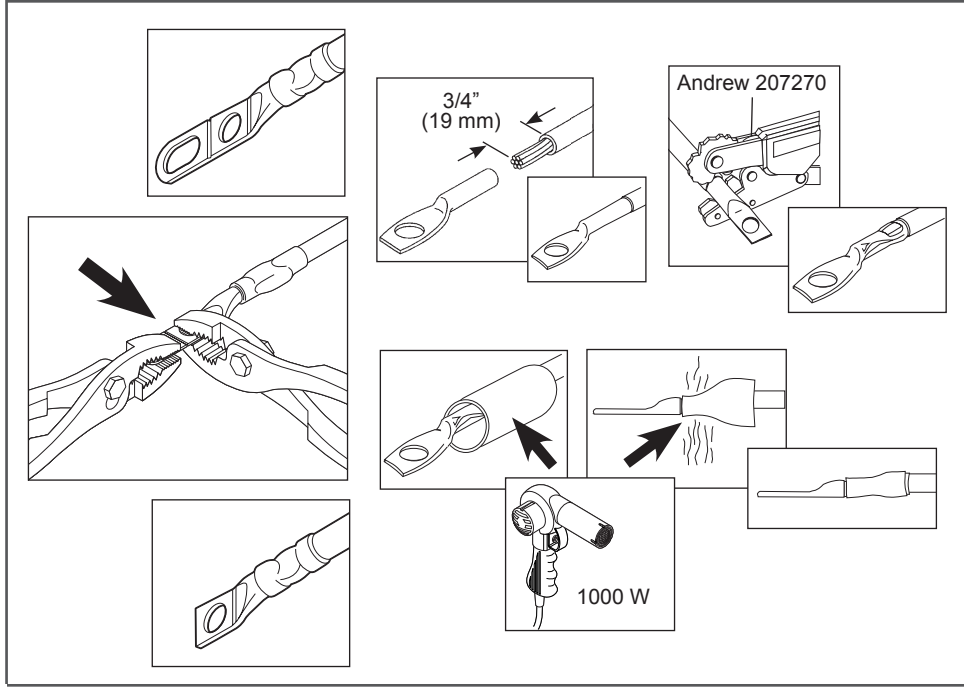
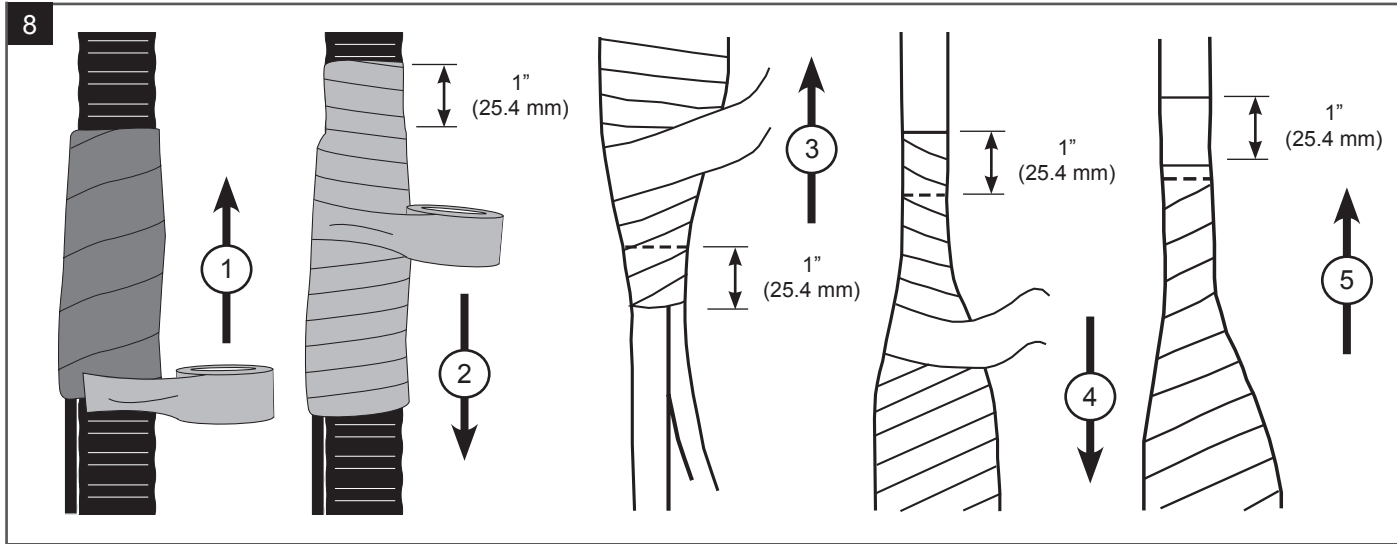

Andrew Wireless Solutions

Customer Service 24 hours
 U.S.A., Canada, Mexico:
 1-800-255-1479 HELIAX products
 1-888-235-5732 Extremerflex products
 U.K.: 0800 250055
 Other Europe: +44 592 782 612

www.commscope.com

Visit our Web site at www.commscope.com or contact your local Andrew Wireless Solutions representative for more information.
 © 2009 CommScope, Inc. All rights reserved.
 Andrew Wireless Solutions is a trademark of CommScope. All trademarks identified by ® or ™ are registered trademarks or trademarks, respectively, of CommScope. This document is for planning purposes only and is not intended to modify or supplement any specifications or warranties relating to Andrew Wireless Solutions products or services.

Notice: Andrew disclaims any liability or responsibility for the results of improper or unsafe installation, inspection, maintenance, or removal practices.
 Aviso: Andrews no acepta ninguna obligación ni responsabilidad como resultado de prácticas incorrectas o peligrosas de instalación, inspección, mantenimiento o retiro.
 Avis : Andrew décline toute responsabilité pour les conséquences de procédures d'installation, d'inspection, d'entretien ou de retrait incorrectes ou dangereuses.
 Hinweis: Andrew lehnt jede Haftung oder Verantwortung für Schäden ab, die aufgrund unsachgemäßer Installation, Überprüfung, Wartung oder Demontage auftreten.
 Atenção: A Andrew abdica do direito de toda responsabilidade pelos resultados de práticas inadequadas e sem segurança de instalação, inspeção, manutenção ou remoção.
 Avvertenza: Andrew declina eventuali responsabilità derivanti dell'esecuzione di procedure di installazione, ispezione, manutenzione e smontaggio improprie o poco sicure.
 注意：Andrew 公司申明對於不恰當或不安全的安裝、檢驗、維修或拆卸操作所導致的後果不負責任 何義務和責任