

Window Intercom System

Surface Mounted Entry System - STS-K009-IP-L-B

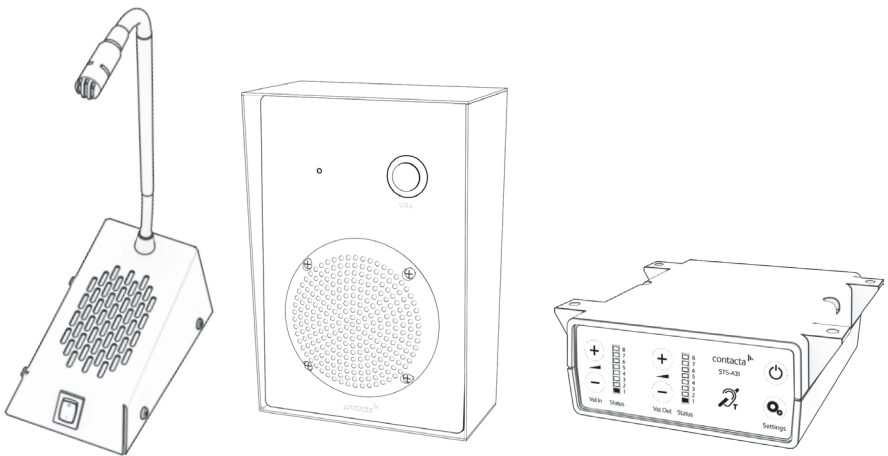

Installation & User Guide

July 2022

Contents

Product Overview	3
Components	3
Connections	4
Installation Instructions	5
Speaker & Microphone Kit Installation	6
Amplifier Installation	6
Speaker & Mic. Kit Installation	7
Hearing Loop Installation	10
Amplifier Setup	11
Cleaning / Maintenance	13
Troubleshooting	14
Engineer's Mode	15

Contacta has a policy of continuous product development, and therefore small specification changes may not be reflected in this manual. Images, labels, packaging, accessories and product colours are subject to change without notice.

Product Overview

This speech transfer system provides high quality sound across partitions or safety screens. It includes our surface mounted entry unit with IP-55 rating, our open duplex amplifier, a hearing loop, and a free-standing microphone and speaker unit for staff.

The surface mounted entry unit (K009-IP) must be installed as per installation instructions to maintain its IP-55 rating.

Speaker & Microphone Components

1. Staff Microphone
2. Surface Mounted Entry Unit
3. Screw Sticker Covers x4

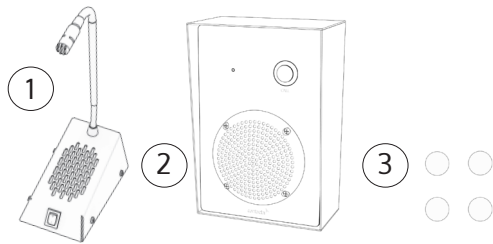

General Components

1. Installation and User Manual
2. Amplifier
3. Hearing Loop Sticker
4. IEC Lead
5. Power Supply
6. Hearing Loop Aerial
7. Mounting Bracket

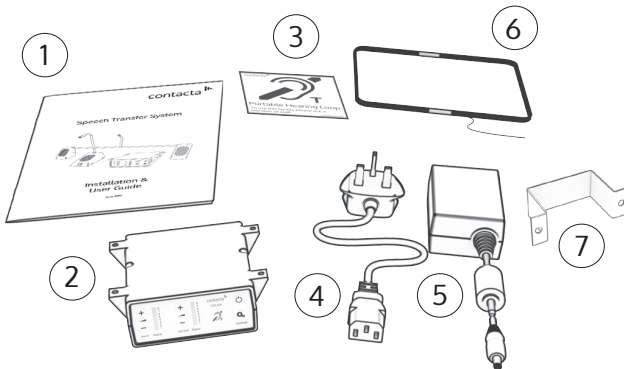

Fixing Kit:

- Adhesive Clip x 10
- No.6 x 1/2" Countersunk Screws x15
- P-Clips x6
- M3 x 24mm Universal Wall Plugs x4
- M3 x 25mm Fixing Screws x4

Connections

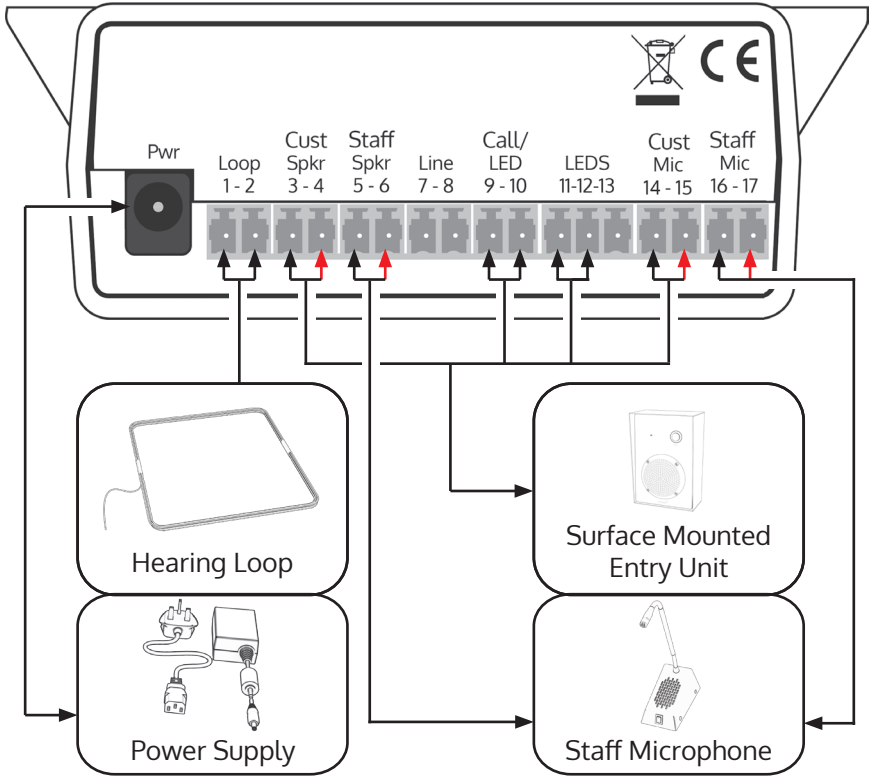

Surface Mounted Entry Unit to Amplifier - Connections Colours

Cable Colour	Amplifier Socket	Amplifier Pin #
Blue	Customer speaker	3-4
Brown	Customer mic	14-15
Green	Call/LED	9-10
Orange	LEDs	11-12

When removing green connectors for feeding cables through holes, ensure all are refitted at the correct polarity before connection to the amplifier.

It is recommended to take photos as a record before taking any cables apart. This is to ensure proper reconnection; incorrect wiring may impact performance.

Installation Instructions

We recommend that installation is carried out by a qualified engineer, adhering to relevant standards.

Check the contents of the box to familiarise yourself with the components.

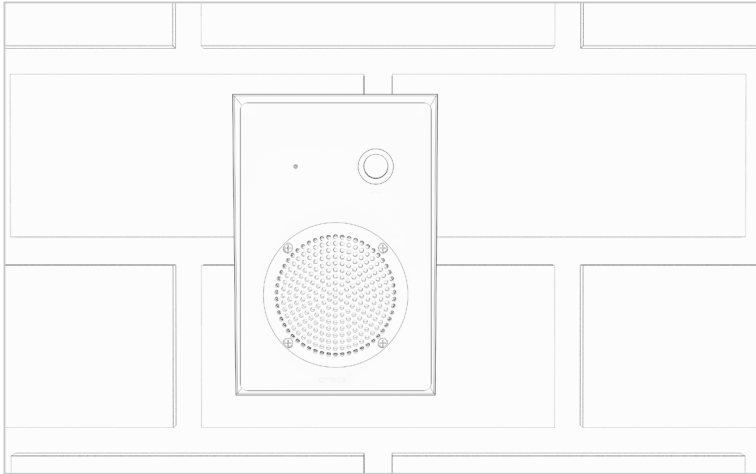

Recommended Tools

A toolkit recommended to install the system will include:

- Screwdrivers (Flat or Blade 2.5mm and Phillips Head PH2)
- Battery or Mains Drill
- Drillbits: 2mm, 3mm, 5mm and 7mm
- Allen Key Set
- Cable Tacking Gun (10mm)
- Wire Cutters/Strippers
- Pliers
- Tape Measure
- Pencil or Marker Pen
- Torch
- Cable Ties
- Electrical Insulation Tape
- Trunking

Trim cables if necessary (excluding the power supply) to the required length to connect to the back of the amplifier. Bare approximately 6mm of the cable ends to connect to the 2 pin plugs.

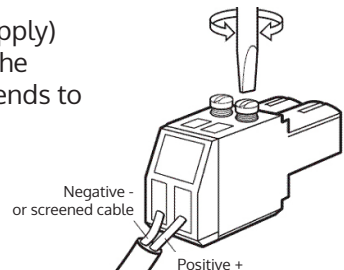

Amplifier Installation

Amplifier Installation

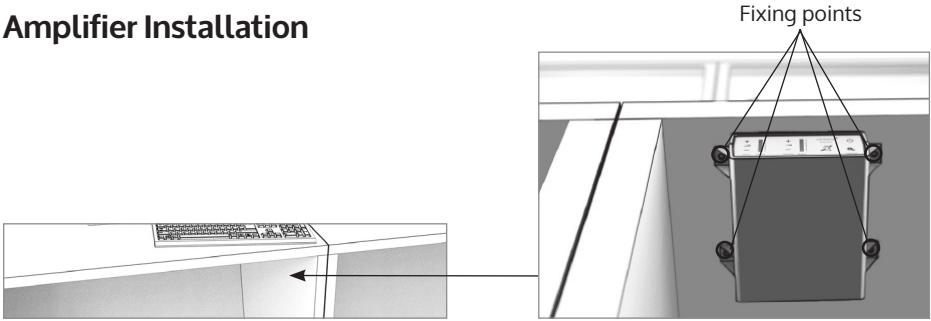

1. Place the amplifier under a staff counter, ensuring that it will not obstruct staff when they are sitting.
2. Mark the four fixing points for the amplifier under the counter.
3. Drill and fix the amplifier in place using the supplied screws.
4. Install the amplifier's power supply close to a power socket outlet using the supplied mounting bracket and fixing screws.

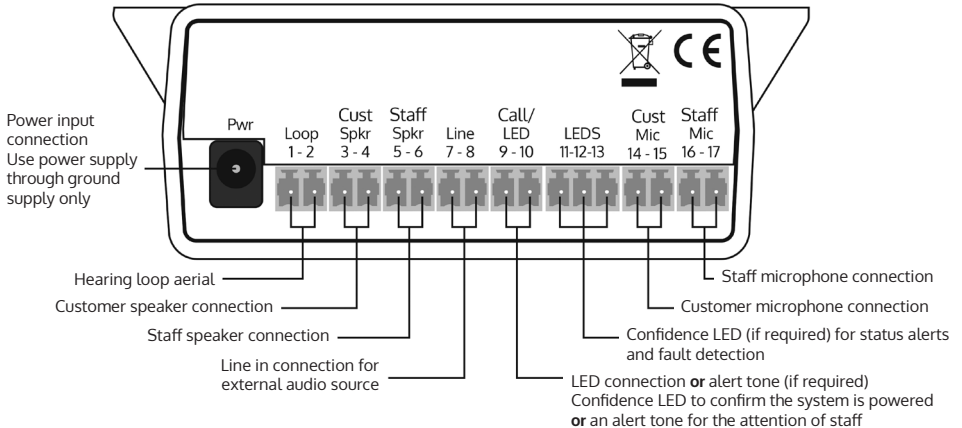

Microphone & Speaker Installation

1. Place the staff microphone on the staff side of the partition, ensuring that it does not cause an obstruction and is as close to staff as possible. It is ideally positioned no more than 300mm away from the staff member.

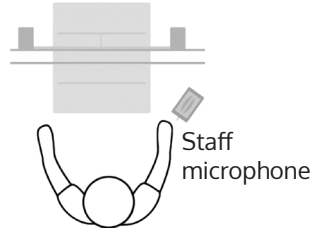

2. Use the cable management hole to run the staff microphone cable back to the amplifier. If there is not already a cable management hole, drill in a suitable location near the rear of the counter.

3. Find a suitable location for the surface mounted entry unit (K009-IP):

- If intended users will be standing, the unit is ideally installed at head height (approx. 1.65m) to allow users to easily speak into it.
- If intended users will be driving, the unit is ideally installed at the head height of users inside their vehicles (average is approx. 1.3m).
- Placement is ideally within physical reach of intended users (at least within 600mm) to ensure they can reach the unit's front button.
- The unit should be installed against a wall or flat surface to ensure maximum ingress protection.

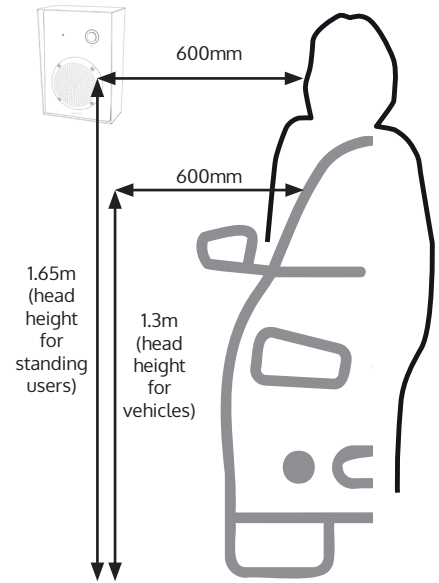

4. Remove the x4 screws that hold the front cover of the unit together and put these to the side.
5. Carefully remove the front cover and locate the x4 fixing point holes. The front cover should be handled with care as it will be wired to the back box.

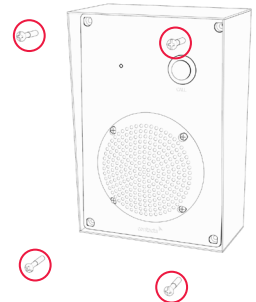

6. Mark the x4 fixing point holes and cable management hole on the mounting surface.

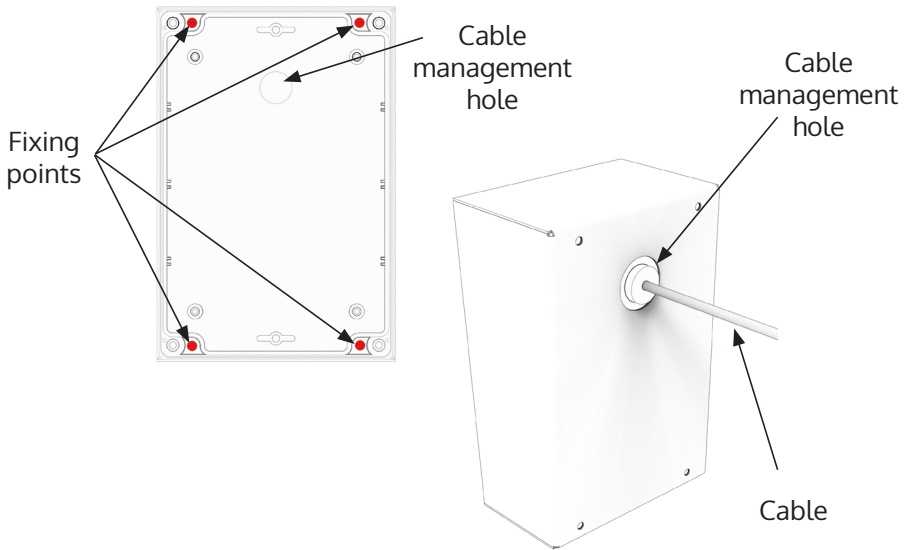

7. Prepare your mounting surface by installing any wall plugs necessary into the fixing points marked.

Note: This kit is provided with x4 universal surface M3 x 24mm wall plugs which require a 5mm pilot hole. Please ensure appropriate fixings are used for your intended surface.

Ensure that cables are routed into the cable management hole prior to securing the back box to the mounting surface.

8. Use x4 25mm fixing screws to secure the box to its intended surface using the holes created in the step 7.

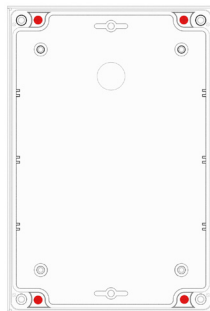

9. Use the x4 removed screws from step 4 to re-attach the front cover to the back box. Ensure the seal is in place and in good condition. Tighten accordingly.

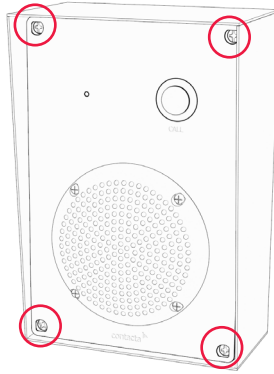

10. Take the x4 supplied screw cover stickers and cover the visible silver screws (highlighted in the image below).

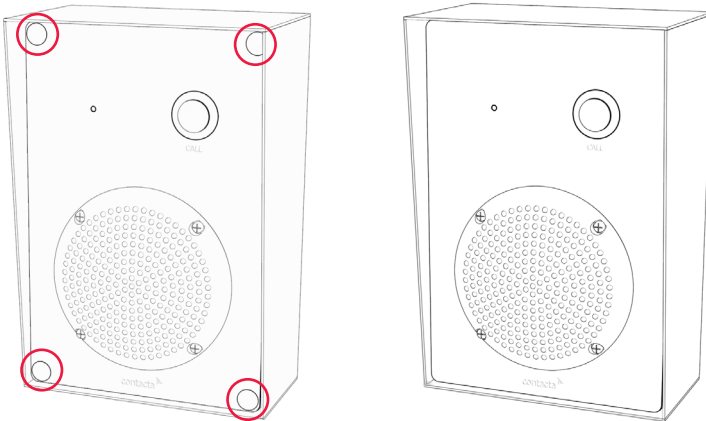

Hearing Loop Installation

The aerial should be fixed under the desk-top or counter centrally on the custome or visitor side, one half mounted horizontally under the counter and the other half mounted vertically, facing the customer/visitor (as in the first scenario below).

Position the aerial under the counter using either the provided P-clips or another fixing method of your choice. See the diagram below for recommended positioning.

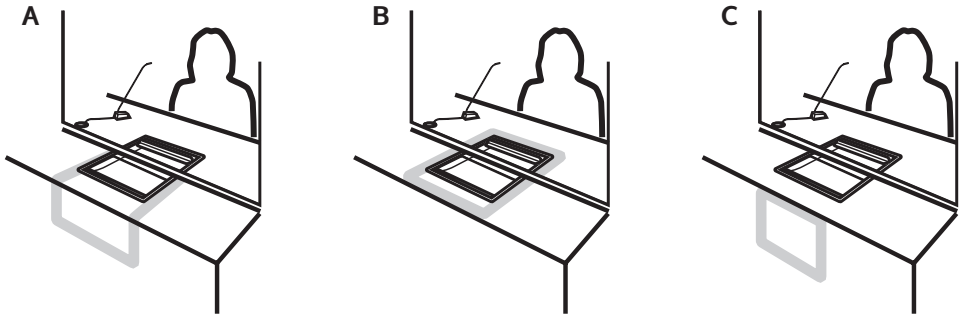

A is the optimum layout for a counter hearing loop.

B and C are acceptable only if A is not possible and the layout is aligned so that the magnetic field will be directed towards user's head heights.

Ensure all hearing loop signage is displayed clearly.

Amplifier Setup

Overview of Front Panel Buttons

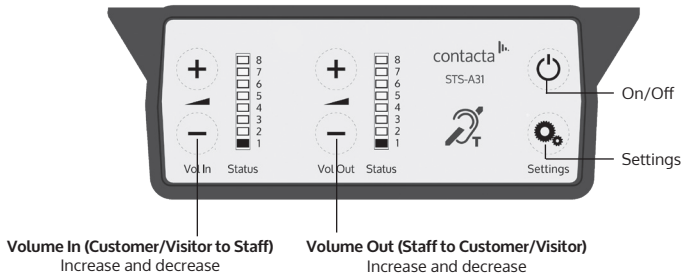

Setup

1. Connect all green plugs to the back of the amplifier, following the locations printed above the sockets (see page 4).
2. Power on the amplifier by pressing the On/Off button.
3. When powered and in normal operational mode the amplifier will display Volume In LED 1 and Volume Out LED 1 as steady green.
4. When the amplifier is switched off, all audio is muted and none of the LEDs are illuminated. Pressing any button will turn the amplifier on again.
5. Adjust Volume In and Volume Out to a comfortable level.
6. Press and hold the Volume In (+) or (-) buttons to increase or decrease the level. The corresponding LED bar will show the volume setting.
6. Ensure the mouse microphones are placed as close to their intended users as possible.
7. Check the amplifier is fully functional by ensuring the red 'fault' light is NOT showing on the front.
8. **The Amplifier is now set up.**

Our Window Intercom System amplifiers are pre-set to volume levels suitable for nearly all users. Should you need to adjust the Maximum Volume, Ducking or Hearing Loop levels outside of the pre-set amplifier parameters, use Engineer's Mode (see page 13).

Fault Diagnosis LEDs

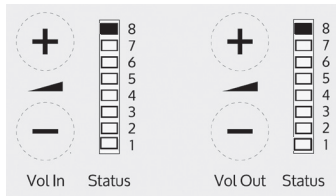

- Volume In LED 8 will stay red if there is a fault with the staff microphone.
- Volume Out LED 8 will stay red if there is a fault with the customer/visitor microphone.
- Volume In LED 8 will flash red if there is a fault with the loop (e.g. a broken aerial).

System Extension Cables

System Extension Cables (CABLE-STX-EX) are available in lengths of 5m, 10m, 15m and 20m. x2 sets of leads are required for the K009-IP connectors.

Connect the plug socket into the K009-IP unit. Connect the other end to the Amplifier.

Test to ensure the surface mounted entry unit (K009-IP) and amplifier are functioning as per usual.

Factory Default Settings

To return the amplifier the factory default settings:

1. Unplug the power supply and then reconnect it.
2. Press the On/Off button and Volume In (-) button together, then release.
3. The Volume In LED bar will have all LEDs illuminated, while the Volume Out LED bar will display the firmware revision number in a fixed pattern of LEDs. This indicates that default settings have been restored.

Cleaning / Maintenance

Ensure that your surface mounted entry unit (K009-IP) is regularly cleaned and maintained.

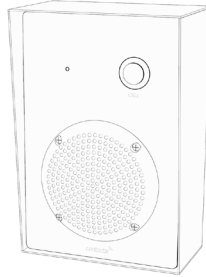

To properly maintain the unit, wipe it with with a damp cloth to remove any dirt or debris. Avoid using harsh chemicals when cleaning the unit as this may cause damage.

Do not attempt to remove any stickers/screws from the unit unless you are a trained Contacta engineer; doing so may void the unit warranty.

If you notice any noticeable damage is inflicted to the unit then please contact your provider/dealer.

Troubleshooting

Symptom	Possible Fault	Action
There is no power detected through the amplifier (and there is power at the socket).	1) Power jack not plugged in or faulty. 2) Plug fuse has blown. 3) Faulty power supply unit. 4) Faulty amplifier.	1) Check power jack is firmly plugged in. 2) Replace fuse. If it blows again, replace the power supply unit. 3) Replace the power supply unit. 4) Replace amplifier.
The red LED is illuminated on front panel.	1) Constant red LED: Staff or customer/visitor microphone fault. 2) Red LED comes on after speech: Induction loop fault.	1) Ensure microphone is wired correctly and firmly plugged in. Try alternative microphone to ensure port is working. 2) Ensure induction loop connector is wired correctly and firmly plugged in.
I can't hear audio through the induction loop.	1) Induction loop or microphone is disconnected. 2) Loop tester has a fault.	1) Check instructions for correct connections and, if possible, check the hearing device with a known working hearing loop. 2) Ensure loop tester has a new set of batteries.
I can hear interference through speakers (buzzing / whistling / hissing).	1) Unscreened or poorly earthed third party equipment is being used in close proximity. 2) Internal volume gain set to high. 3) Incorrect power supply being used.	1) Switch off any third party equipment to identify the source of interference. 2) Access the amplifier engineers mode to adjust the internal settings. 3) Ensure that our grounded power supply unit is connected.
Amplifier goes into feedback.	1) Internal volume gain set to high. 2) Microphone positioned too close to speaker.	1) Access the amplifier engineers mode to adjust the internal settings. 2) Move the microphone to a location further from the speaker.
Unit does not go into power saving mode.	1) Ambient noise in area is too high.	1) Switch off any air con systems, desktop fans and/or computers to reduce ambient noise.

If no action is successful please seek assistance from your distributor or a Contacta installer.

Engineer's Mode

Engineers Mode allows you to adjust the Volume In and Out levels, Ducking levels and Hearing Loop levels to better suit your environment and achieve the best possible performance.

Before entering Engineer's Mode, cycle the power. To do this either:

- Switch the power off at the mains socket and back on again
- Remove the power connector and re-insert it

To enter Engineer's Mode, simultaneously press and release the following buttons within 20 seconds of cycling the power:

- Settings button
- Volume In increase button
- Volume Out increase button

Number 1 LED on the Volume In will flash green to indicate that you are in Engineer's Mode.

The on/off and settings buttons in Engineer's Mode operate as follows:



Move to the next setup area



Save and exit Engineer's Mode

The amplifier will automatically exit Engineer's Mode if no buttons are pressed for 2 minutes.

There are 3 editable setup areas in Engineer's Mode. You will always enter setup area 1 first. The green Volume In LED bar will flash to indicate which setup area you are in.

Setup Area 1: Maximum Volume Adjustment (LED 1 flashes)

Setup Area 1 allows you to adjust the Volume In and Volume Out levels to further optimise the system for the environment in which it is installed.

Increase maximum staff volume level

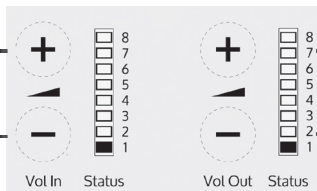

Decrease maximum staff volume level

Increase maximum customer volume level

Decrease maximum customer volume level

1. Ensure the customer/visitor and staff volumes are turned down.
2. Adjust staff (Volume In) volume to a comfortable level. Press and hold the Volume In (+) or (-) buttons to increase or decrease the level. The corresponding LED bar will show the volume setting.
3. Raise customer/visitor (Volume Out) volume until feedback is heard. Press and hold the Volume Out (+) or (-) buttons to increase or decrease the level. The corresponding LED bar will show the volume setting.
4. Lower customer/visitor (Volume Out) volume until feedback is eliminated.

Setup Area 2: Ducking Adjustment (LED 2 flashes)

Setup Area 2 allows you to adjust the Ducking level or to turn it on/off.

The ducking function is provided to reduce feedback on a window intercom system. Feedback occurs when the overall setting of both volume controls is too high. The ducking system works by detecting which microphone in the conversation is being used, and temporarily reducing the volume setting.

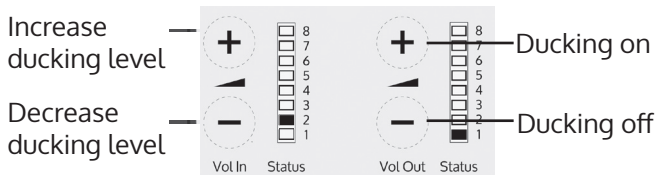

Setup Area 3: Hearing Loop Drive Adjustment (LED 3 flashes)

Setup Area 3 allows you to adjust the Hearing Loop Drive or to turn it on/off.

Hearing loops improve communication by enabling hearing device users to hear sound sources directly, cutting out background noise.

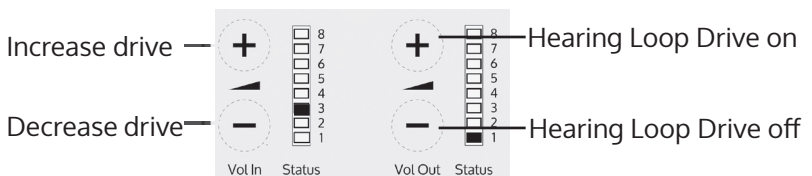

The drive levels should be adjusted so the red LED 8 is illuminated only when

there are peaks in the speech volume.

If the amplifier does not have a loop attached, turn the Hearing Loop Drive off as indicated in the diagram above.

contacta

Further information is available on our website and our YouTube channel.



Window Intercom STS-A31H Amplifier
Setup Video

www.contacta.co.uk
sales@contacta.co.uk
+44 (0) 1732 223900
Technical Support - Ext 5