

SOFIA 565

FM SiteStreamer+™

Installation & User Guide



PRODUCT REGISTRATION RECORD

SOFIA 565 – Serial No. _____

Purchase Date _____

Warranty Registered? Web

Reg. Date _____ By: _____

Installation & Operation User Guide

SOFIA 565

FM SiteStreamer+™

October, 2019
Firmware Rev. 1.0.0.0

Inovonics, Inc. 5805 Highway 9
Felton, CA 95018
Tel: (831) 458-0552 Fax: (831) 458-0554
Register online at www.inovonicsbroadcast.com

TABLE OF CONTENTS

Section I – INTRODUCTION

SOFIA 565 PRODUCT DESCRIPTION	
‘SiteStreamers’ Defined.....	6
Product Features	6
SOFIA 565 TECHNICAL SPECIFICATIONS	
Specifications.....	7
Block Diagram.....	8

Section II – INSTALLATION

GENERAL	
Unpacking and Inspection.....	9
MOUNTING, POWER AND ENVIRONMENT	
Rack Requirement.....	9
Heat Dissipation.....	9
AC Mains Power.....	10
Radio Frequency Interference (RFI)	10
Ground Loops.....	10
INPUTS, OUTPUTS AND PORTS	
Antenna Input and Considerations	10
Analog Line Outputs.....	10
Unbalanced Operation.....	11
AES Digital Line Output.....	11
AoIP Streaming Port and Levels	11
LAN Network Port	11
GPOs	11

Section III – SETUP AND OPERATION

PRELIMINARY INFORMATION	
Quick Boot.....	12
Front Panel vs. Web Interface Setup.....	12
THE SOFIA 565 FRONT PANEL	
The Jog-Wheel Knob.....	12
The BACK Button.....	13
Graphic Display.....	13
Local Alarms	13
Level Meters.....	13
Menu Timeout and Screensaver.....	13

THE FRONT-PANEL MENU TREE	
Menu Tree.....	13
GETTING UP AND RUNNING	
The Main Menu.....	15
Finding the SOFIA 565's IP Address.....	15
Assigning a Fixed IP Address.....	15
Connecting to the SOFIA 565.....	15
NOW PLAYING	
Remote Listening.....	16
'VU' Meter.....	17
Signal Metrics.....	17
Alarms.....	17
Audio Program Metadata.....	17
Tuning the Radio.....	18
The Split Mode.....	18
Station Presets.....	18
StationRotation™.....	18
GRAPHS AND METERING	
Audio Level Metering.....	18
Histograms.....	19
The BandScanner™ Utility.....	19
The 'Extended' FM Band.....	21
RDS INFO	
RDS Data Display.....	21
ALARMS	
Alarm Status.....	22
Audio Loss.....	22
Low Signal.....	23
RDS Alarm.....	23
RT Update.....	24
Pilot Loss.....	24
Alarm Logging.....	24
SETUP	
Radio Settings.....	25
Audio Outputs.....	25
General Purpose Outputs.....	26
NETWORK SETUP AND INTERNET ACCESS	
IP Setup.....	27
Assigning a Hostname.....	27
HTTP Port.....	27
MAC Address.....	27
Link Speed.....	27
Addressing the SOFIA 565.....	27
Incoming Internet Access.....	28

DANTE®	
IP Settings Mode	28
AES67 and AoIP Streaming	28
The AoIP MAC Address	29
Link Speed.....	29
Audio Format	29
Transmit Flows.....	29
The Dante Controller.....	29
SNMP OPERATION	
Mode.....	30
Security	30
Ports	30
Trap Destinations.....	30
The MIB File.....	30
EMAIL	
Email and Text Notifications.....	30
SMTP Setup.....	30
Recipients (Send To).....	31
Notifications (Send What).....	31
TIME SETUP	
Time and DST	32
Presentation Formats	32
RTC Battery	32
Time Server	32
ADMINISTRATIVE MATTERS	
Security and Passwords.....	32
Signing In	33
Lost Password (Hard Reset).....	33
The Hardware Profile	33
Reboot	34
Updating Firmware.....	34
'About' Info.....	35
INOVONICS WARRANTY	(INSIDE BACK COVER)

Section I

INTRODUCTION

SOFIA 565 PRODUCT DESCRIPTION

**‘SiteStreamers’
Defined** Inovonics’ SiteStreamers™ are Web-enabled, off-air radio receivers that allow a broadcaster to monitor his station from a remote location beyond the station’s coverage area. Using any computer or mobile device, station personnel can listen to the audio program and read associated metadata and signal metrics.

The elite SiteStreamer+™ (‘plus’) series includes additional features. The SOFIA 565 has AoIP connectivity and can provide a signal metrics history of an entire broadcast day, as well as validating and displaying RDS/RBDS program-related metadata.

**Product
Features**

Leading features of the Inovonics SOFIA 565 include:

- All-digital “SDR” (Software-Defined Radio) off-air reception of analog-FM and RDS/RBDS data.
- Stays on-channel and holds user settings through signal and power losses.
- Provides analog, AES3-digital, Web-streaming and independent AoIP-streaming program audio outputs.
- Collects and displays a history of signal parameters.
- StationRotation™ allows automatic sequential monitoring of multiple stations.
- Dispatches SMS-text or email messages to specific individuals for various alarm conditions; logs alarms chronologically with the internal real-time clock.
- Intuitive, menu-driven front-panel setup. The built-in Web server allows remote setup and full operation over any IP network. Supports SNMP remote monitoring.
- The built-in BandScanner™ utility gives a spectrum plot of the entire FM band, or a specific portion, and notes stations on-screen through RDS identification.

SOFIA 565 TECHNICAL SPECIFICATIONS

Tuning Range: 64.0MHz-107.9MHz in 100kHz steps.

Antenna Input: 75-ohm (BNC).

Sensitivity/SNR: 20dBuV required for 50dB unweighted, monaural analog-FM S/N.

Off-Air Frequency Response: ± 1 dB, 20Hz-15kHz.

Stereo Separation: >40dB

FM De-emphasis: 75 μ s or 50 μ s, menu-selectable.

IF Bandwidth: Auto (signal-dependent), 110kHz, 84kHz, 60kHz, 40kHz; menu-selectable.

Highcut (audio cutoff): Disabled, 11kHz, 8kHz, 6kHz, 5kHz, 4kHz, 3kHz, 2kHz; menu-selectable for noise abatement.

Reception Modes: Stereo / Stereo Auto-Blend / Forced-Monaural.

RDS Fields Displayed: PS, PI (and Call), RT, RT+1, RT+2, PTY, PTYN, CT, M/S, DI, TP, TA; RDS Block Error Rate, Groups Transmitted (with use statistics), AF, ODA.

Graphs and Metering: L, R, L+R, L-R Program Audio; Audio (Loudness) Histogram; RSSI, RF SNR, Multipath measurements and histograms.

Program Audio Outputs:

Balanced Analog: (XLR) Left and Right outputs, adjustable from -15dBu to +15dBu in 0.1dB steps.

AES Digital: (XLR) output at 44.1kHz or 48kHz, adjustable from -30dBFS to 0dBFS in 0.1dB steps.

Dante/AES67 Compatible: (RJ45) AoIP output at 44.1kHz (Dante) or 48kHz (Dante/AES67), adjustable from -30dBFS to 0dBFS in 0.1dB steps.

Headphone Jack: (3.5mm TRS) with adjustable listening level.

Streaming Audio:

Web-browser 'remote listening' stream has MP3 or OGG (selectable) encoding and offers bit-rates from 32kbps to 256kbps and sampling rates from 16kHz to 48kHz; accommodates up to 10 simultaneous listeners.

Alarms:

Audio Loss: 'Silence Sensor' Alarm has programmable On/Off thresholds and Time On/Off intervals.

Low Signal: Alarm and reset trigger levels are independently adjustable relative to the FM carrier level display and have programmable Time On/Off settings.

RDS Alarm: Programmable Time On/Off for RDS Loss or PI Error (hijacking).

Pilot Loss: Programmable Time On/Off for loss of Stereo Pilot.

Email Alerts: Email or SMS/text-messaging can alert selected personnel to specific alarms.

Alarm 'Tallies': Individual open-collector NPN transistor outputs to ground are programmable for logic polarity and GPO assignment.

Real-Time Clock:

Auto-sets to Internet time; auto/manual DST setting; battery backup.

AoIP Port:

Dante-based, AES67-compatible (selectable) AoIP utility has independent IP, Audio Format and Transmit Flow settings.

LAN Port:

LAN connection to local network or Internet provides remote monitoring, listening and control; user-programmable network setup and streaming parameters.

Power Requirement:

12VDC at 390mA; a universal 88-264VAC, 50/60Hz inline switching power supply is supplied with the SiteStreamer+.

Mounting Options:

An optional rack adapter mounts one or two half-rack modules in a 1U, 19-inch rack space.

Operating Environment: 32°F/0°C-122°F/50°C; 0% - 95% non-condensing relative humidity; 10,000ft/3048m

Size and Weight:

1.6"H x 8"W x 6"D; 5 lbs. shipping weight.

Conformances:



EN50081-1
EN50082-1
93/68/EEC



2002/95/EC

BLOCK DIAGRAM

The SOFIA 565 is a Software-Defined Radio (SDR) receiver. Other factors in its design make the product almost entirely DSP-based with virtually all functionality provided through firmware coding. The Block Diagram presented here illustrates product basics in an easily-understood form, although actual signal paths and logical functions may deviate appreciably from the circuit shown here.

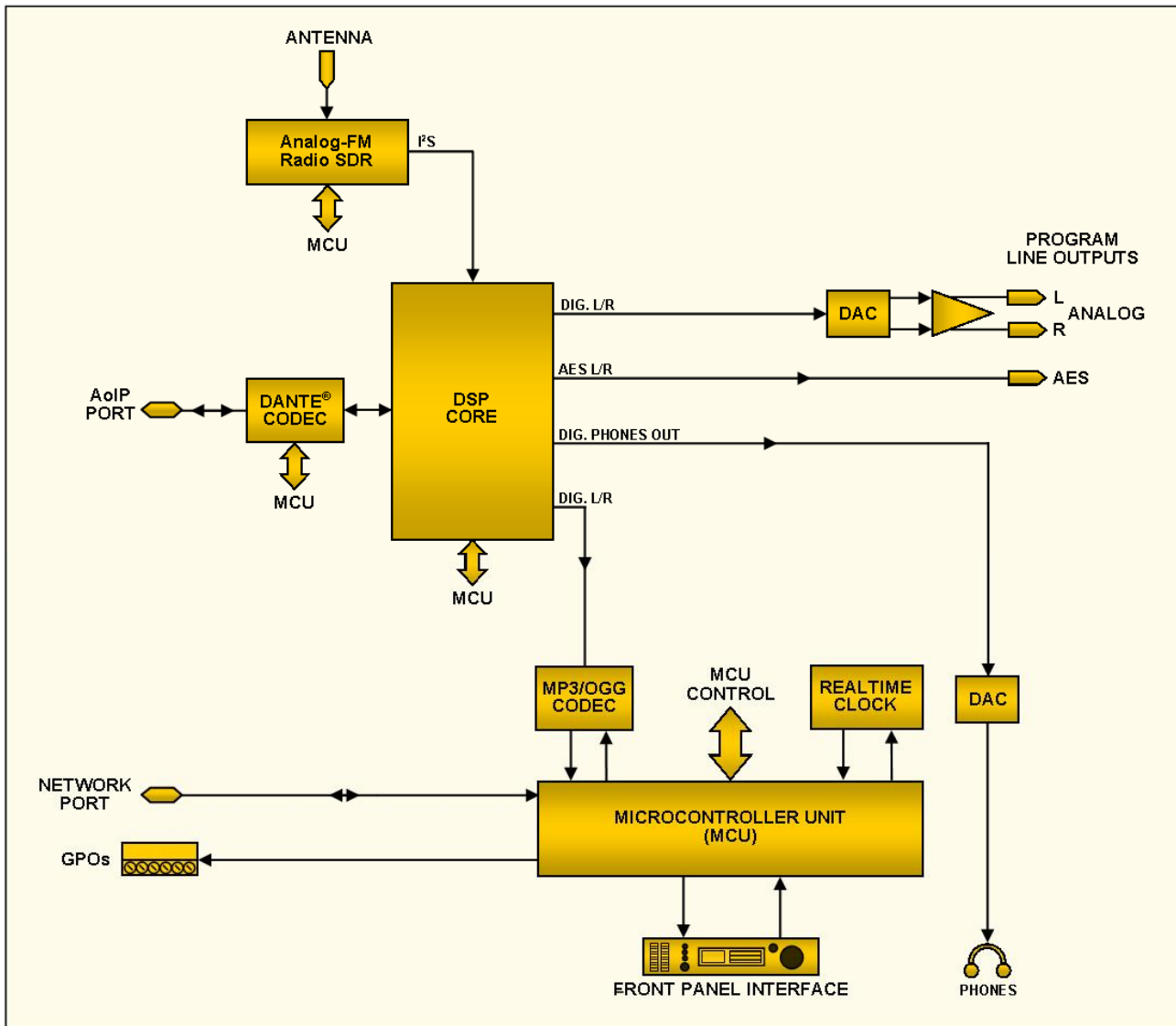

Block Diagram – SOFIA 565 FM SiteStreamer+

Section II

INSTALLATION

GENERAL

This section of the manual addresses the physical installation of the SOFIA 565 at its operating location, the ‘nuts and bolts’ of connecting the unit. This section also references pages where pertinent setup adjustments are discussed.

Many users choose first to familiarize themselves with equipment on the bench or at their desk, in which case they may immediately turn to Section III that describes SOFIA 565 setup and use. When the time comes, do please refer back to this section to confirm proper physical installation and interconnection with other station equipment.

Unpacking and Inspection

As soon as the equipment is received, inspect carefully for any shipping damage. If damage is found or suspected, notify the carrier at once, and then contact Inovonics.

We suggest that you retain the original shipping carton and packing materials for possible return or transshipment. If returned for Warranty repair, shipping damage sustained due to improper packing for return may invalidate the Warranty!

IT IS IMPORTANT to register the Warranty of your SOFIA 565. This assures coverage of the equipment under Warranty terms, provides a means of tracing lost or stolen gear, and adds the user to a database to receive specific service instructions or software/firmware updates when issued. Register online at:

www.inovonicsbroadcast.com/support/productRegistration

MOUNTING, POWER AND ENVIRONMENT

Rack Requirement

The optional 1U rack-mount chassis will accommodate either one or two half-rack Inovonics modules, or one half-rack and one one-third-rack size in the INOmini™ series. Appropriate blanking panels are provided with the rack-mount kit.

Heat Dissipation

Consuming little power, the SOFIA 565 generates negligible heat itself, thus no noisy internal fan and bothersome filter. The unit is specified for operation within an ambient temperature range between freezing and 120°F/50°C. Because adjacent gear may radiate substantial heat, be sure that the equipment rack is adequately ventilated to keep internal temperature below the specified maximum ambient.

AC Mains Power	<p>The SOFIA 565 is provided with an external, inline ‘universal’ switching power supply that accommodates mains voltages between 88VAC and 264VAC at 50 or 60Hz. Self-protection circuits obviate the need for an external fuse.</p> <p>The power supply has a detachable IEC-type power cord fitted with a North-American-standard male plug. If you need to replace the mains plug with another, you will find that the individual cord conductors are color-coded in one of two ways. US standards specify black for AC ‘hot,’ white for AC neutral and green for earth ground. European CEE standards specify brown for AC ‘hot,’ blue for AC neutral and green with a yellow stripe for earth ground. Please don’t mix these up.</p>
Radio Frequency Interference (RFI)	<p>Although it is expected that the SOFIA 565 will be co-located with other radio equipment, do practice care and common sense in locating the unit away from <i>abnormally</i> high RF fields.</p>
Ground Loops	<p>A mains frequency or RF ground loop could possibly be formed between cable shield grounds and the AC power cord ground. If hum or other constant noise is noted, a ‘ground-lifting’ AC adapter may remedy the problem, although the chassis must somehow be returned to earth ground for safety. The optional rack-mount chassis should satisfy this requirement.</p>

INPUTS, OUTPUTS AND PORTS

Antenna Input and Considerations	<p>The rear-panel ANTENNA connector is a female, 75-ohm BNC connector. While the BNC may seem a bit odd for an antenna connection, it is nonetheless a ubiquitous connector worldwide, and adapters to other connector types are plentiful and readily available.</p> <p>Many factors will guide your selection of an antenna, not the least of which is the level and purity of the available off-air signals of interest. Although the selectivity of the SOFIA 565 is remarkably good, it’s not unlikely that a band-pass or band-stop filter could be required for situations where the receiver is co-located with high power FM transmitters working close to desired receive frequencies.</p>
Analog Line Outputs	<p>Male XLR left- and right-channel ANALOG OUTPUTS on the rear panel are electronically-balanced. This means that they are ground-referenced and <i>not</i> transformer-isolated.</p> <p>Analog line outputs may be adjusted under the front-panel Setup / Audio Outputs / Analog Level menu. These may be set to any level between -15dBu and +15dBu, corresponding to $\pm 75\text{kHz}$ deviation (100% modulation). The dB levels shown beside the slider control represent the <i>unloaded</i> output level. These outputs have a resistive source impedance of 200 ohms. Feeding a 600-ohm-terminated load will drop the actual dBm level 2.5dB below the figure shown by the slider.</p>

Unbalanced Operation	<p>If the analog line outputs of the SOFIA 565 are connected to low-level, unbalanced inputs of consumer-grade equipment, connect the center conductor of the shielded output lead to Pin 2 of the XLR connector and the shield to Pin 1. Leave Pin 3 unconnected.</p> <p>When driving unbalanced lines, the actual output level will be 6dB lower than the Analog Level shown in the menu as only one side of the bridge-configuration output stage is driving the load.</p>
AES Digital Line Output	<p>The male XLR connector labeled AES DIGITAL OUTPUT is a balanced, transformer-coupled digital AES3 stereo program output. This is a 24-bit output at either a 44.1kHz or a 48kHz sample rate (follows Dante sample rate settings, see Page 28).</p> <p>The digital output level is set on the Setup / Audio Outputs / Digital Level menu. The dBFS notation beside the slider control corresponds to the level of program peaks at ± 75kHz FM carrier deviation (100% modulation). The digital output level is adjustable between 0dBFS and -30dBFS.</p>
AoIP Streaming Port and Levels	<p>The Dante-compliant AoIP (Audio over Internet Protocol) output appears at the rear-panel RJ45 AoIP PORT. This port is independent of the SOFIA 565 LAN PORT network connection.</p> <p>The AoIP streaming output level is set on the Setup / Audio Outputs / AoIP Level menu. The dB notation beside the slider control corresponds to the level of program peaks at ± 75kHz FM carrier deviation (100% modulation). This level is adjustable between 0dBFS and -30dBFS.</p>
LAN Network Port	<p>The RJ45 LAN PORT jack is used for networking the SOFIA 565 via a Local Area Network (LAN) or the Internet. Networking permits full remote control and the Web-browser ‘casual listening’ utility that can accommodate up to 10 simultaneous listeners. The LAN PORT also offers full SNMP functionality. Networking setup is explained starting on Page 27.</p>
GPOs	<p>A screw-terminal strip on the rear panel gives access to four GPO (General-Purpose Output) terminals. The terminal block may be unplugged from the chassis for easier connection.</p> <p>GPOs may be assigned to reception- and program-fault alarms. Programming these terminals is detailed on Page 26. These GPOs are NPN transistors that saturate to ground and are able to sink up to 100mA. Alarm polarity (active = ground or active = open) is programmable through the front-panel jog knob or Web interface.</p>

Section III

SETUP AND OPERATION

PRELIMINARY INFORMATION

Quick Boot 'Boot' (startup) time of SOFIA 565 is about five seconds. When power is first applied, or following a power interruption, the unit is back in full operation very quickly. Setup and reception parameters in use prior to the power cycle are reloaded instantly from non-volatile memory into the processing core.

Front Panel vs. Web Interface Setup The SOFIA 565 may be placed in initial service either through local, front-panel setup or by using the Web interface. Although a good many of the SOFIA 565 functions and features are addressable only through the Web interface, some familiarity with the front-panel appointments is necessary to get the unit up and running.

THE SOFIA 565 FRONT PANEL

All setup and operating adjustments of the SOFIA 565 are under firmware control. There are no jumpers, switches or mechanical potentiometers, only the front-panel jog-wheel knob A and Back button B identified in this front-panel rendering.

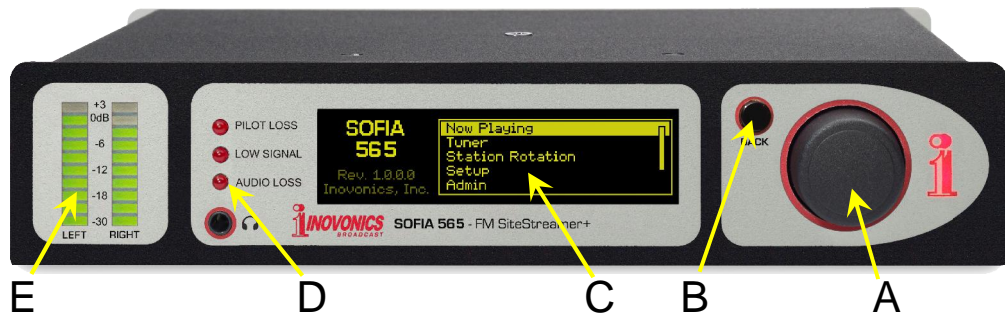

The Jog-Wheel Knob Turn the jog-wheel knob A to cycle the highlight through the various menu options, and then *push* the knob to select the highlighted item. This will move you to the next submenu, although there may be multiple menu levels for the item you need to reach. Once you do reach a submenu that allows control over a function, you *turn* the knob to bracket the adjustable function, and then *push* to access that function. The bracketed item will begin flashing, and you *push* or *turn* as required to make a selection or to set an adjustable parameter, or even to enter text.

	<p>If you dawdle or simply walk away, after 30 seconds of no further knob activity the SOFIA 565 will enter a selection you have made into memory automatically, or simply ‘deselect’ the highlighted item with no changes if the setting has not been altered.</p>
The BACK Button	<p>BACK button B will always return you to the previous menu screen. Push it repeatedly to go back to the Main Menu shown in the illustration.</p> <p>If you make a mistake (for example, you might <i>push</i> the knob slightly off-center, rotating it and bringing up the wrong menu), simply push the BACK button to return to the previous menu and try again.</p>
Graphic Display	<p>OLED graphic display screen C presents an abbreviated, intuitive setup menu tree in an easy-to-follow format. The display uses a screen saver, so if the screen goes dim or dark, simply <i>push</i> the jog-wheel knob or BACK button once to bring the screen back to life. No selection or change is made with this wakeup call.</p>
Local Alarms	<p>Front-panel alarm LEDs D indicate critical reception errors. Programming the alarm thresholds and delays is accomplished through the Web interface as described starting on Page 22.</p>
Level Meters	<p>LED-segment meters E are LEFT and RIGHT channel audio level indicators with <i>peak response</i> to program dynamics. A floating peak-hold segment catches the most recent peak level.</p> <p>The full-scale 0dB reference corresponds to $\pm 75\text{kHz}$ monaural-FM modulation. Meter scaling is linear at 3dB per segment down to -18dB, then 6dB per segment to -30dB.</p> <p>Because these meters are peak- rather than average- or VU-responding, you’ll find that they will probably hover right at the top of the scale during most music programming, which sadly nowadays has very limited dynamic range.</p>
Menu Timeout and Screensaver	<p>After making and saving a setting, you may press the BACK button to return to the Main Menu screen, or simply leave any current screen showing.</p> <p>A programmed interval may be set under the Admin / Display menu to adjust screen brightness and to dim or turn off the OLED screen when the SOFIA 565 is unattended. This is a recommended practice that prolongs the life of the display. At any time, however you can press the jog-wheel knob or BACK button to wake the screen.</p>

THE FRONT-PANEL MENU TREE

The several levels of front-panel setup and operating menus are laid out in an intuitive and easy-to-manage fashion. The complete Menu Tree is detailed below. Keep in mind that the front-

panel Menu Tree is a much-abbreviated version of total SOFIA 565 setup and operation navigation.

Menu Titles are shown here in a font similar to the OLED display font. Primary menu items are against the left margin and sub-menu levels are indented appropriately.

Menu items are tagged here to show whether the item is a readout (display) of some parameter, or if it accepts some form of user entry (data entry). (set) signifies an on/off or enable/disable function, and (select) denotes user control over multiple-choice selections, or for adjusting some value incrementally. (data entry) calls for alphanumeric character entry into data fields. Data entry is a bit cumbersome with the jog-wheel knob and is much more easily done through the Web interface.

SOFIA 565 FRONT-PANEL MENU TREE

Now Playing	Setup / Network / IP Settings (continued)
Freq (display)	Gateway (data entry)
PI (display)	DNS (data entry)
Call (display)	Hostname (data entry)
RSSI (display)	HTTP Port (data entry)
PS (display)	MAC (display)
MP (display)	Speed (<i>Link Speed</i>) (display)
RT (display)	Time
Blend (display)	Time Zone (select)
Tuner	DST (select)
Frequency (select)	Format (set X2)
RSSI (display)	Server (data entry)
SNR (display)	AoIP/Dante (<i>NOTE</i> : this submenu is program-
ST Mode (select)	mable only through the Web interface)
IF BW (select)	DHCP (display)
Highcut (select)	IP (display)
Station Rotation	Subnet (display)
Enable (set)	Gateway (display)
Rotation Time (select)	DNS (display)
Setup	MAC (display)
Radio	Speed (<i>Link Speed</i>) (display)
De-Emphasis (select)	Admin
RDS/RBDS (set)	Security (Passwords)
Audio Outputs	Front Panel (data entry)
Analog Level (select)	Webpages (data entry)
Digital Level (select)	Display
AoIP Level (select)	Brightness (select)
General Purpose Outputs	Timeout (select)
Output 1-4 (select)	Dim on timeout (set)
Type (select)	About
Polarity (set)	Firmware Rev (display)
Status (display)	Serial # (display)
Network	Uptime (display)
IP Settings	Headphone Volume
DHCP (set)	Volume (set)
IP (data entry)	
Subnet (data entry)	

GETTING UP AND RUNNING

The Main Menu Push the BACK button until you see the Main Menu on the OLED display. This is the 'gateway' for setup and operation.

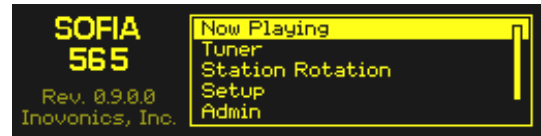

With the SOFIA 565 connected to your local network (LAN), use the jog wheel to navigate from the Main Menu to: Setup / Network / IP Settings.

Finding the SOFIA 565's IP Address

This image is typical of what your unit should now display. Under the default DHCP control selection, your router should have assigned the SOFIA 565 an IP address. In this example the DHCP assignment is IP: 10.0.0.16. Note that this menu screen holds more IP address information; turn the knob to scroll down.



Assigning a Fixed IP Address

To assign the SOFIA 565 a fixed IP address, clear the DHCP box and then navigate through the various fields on this screen, entering the called-for information manually in each. Be sure to execute a Save after entering the IP data in the appropriate fields.

Connecting to the SOFIA 565

On your computer connected to the same network, open a browser window and enter the SOFIA 565 IP address into the address bar using the IP: displayed on the front-panel OLED screen. The Now Playing screen should pop-up like the one shown here.

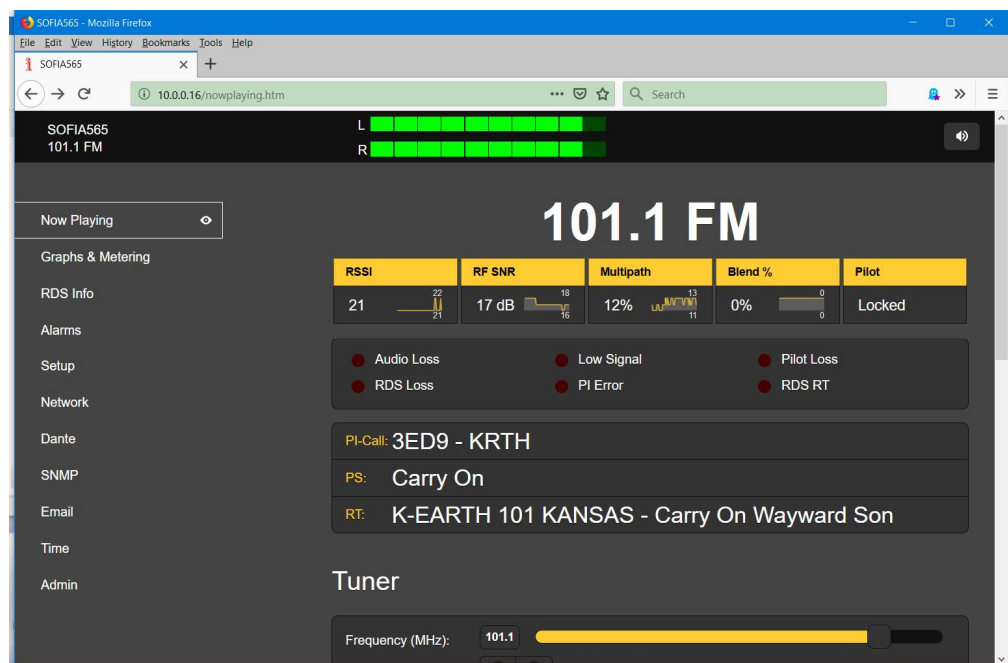

The ‘responsive’ design of the SOFIA 565 Web interface provides an optimal viewing experience across a wide range of devices, such as desktop computers, tablets, and mobile phones.

SOFIA 565 Webpages feature the unabridged Main Menu on the left-hand side of the screen. This columnar list appears on every Web interface screen. It is a substantial expansion of the front-panel Main Menu and a testament to the many features and their setup options that can only be addressed using the Web interface.

The remainder of this manual section will be devoted to individual explanations of each left-column menu item, discussed in listed order.

NOW PLAYING

The SOFIA 565 offers an array of OLED and Web interface meters and data readouts useful for setup and for monitoring program-associated metadata and certain important signal parameters.

The Web interface identifies the product model and shows the tuned frequency at the top of each Webpage. This name, the ‘Hostname,’ can be personalized (see Page 27).



Remote Listening

Click the loudspeaker icon at the top-right of the screen to listen to the off-air audio program through your Web browser.



Your listening selection will be valid for ‘casual’ audio streaming (Web listening), the separate AoIP-streaming utility, and the rear-panel analog and AES-digital program line outputs. In other words, whatever station you tune will be heard on *all* audio monitor functions.

Streamed audio has additional Webpage-only settings under **Setup / AUDIO OUTPUTS / Stream**. Briefly navigate to that page and check the default settings. You will find that the streaming Format:, Bitrate: and Sample Rate: may be changed from the default settings as may be required to accommodate inconsistent network quality. In addition, a preset Audio Latency (delay) may be purposely introduced to add intentional buffering for smoother, albeit delayed, program delivery.

As many as ten Web-streaming listeners can be accommodated with the SOFIA 565’s stream-listening utility. The maximum number can be preselected with the Max Listeners: slider.

Keep in mind that the Web listening stream is ‘packetized’ for IP transmission somewhat differently than radio remote-control and metering functions. Thus program audio and the meter response may be substantially offset in time.

The independent AoIP audio streaming provision is covered separately on Page 28.

‘VU’ Meter

As explained earlier, SOFIA 565 metering is peak-responding, and the Web interface “VU” display at the top of each Web interface page follows the 10-segment front-panel LED bar readout. Refer back to Page 13 for additional info on this. Metering with higher resolution is displayed on the Graphs & Metering Web interface page and is covered under that discussion.



Signal Metrics

Directly under the prominent frequency notation near the top of the page, you’ll find a series of off-air signal quality readouts.

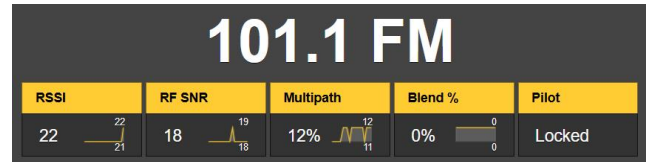

With the exception of Pilot, which indicates only a Locked or an Unlocked condition, each of the other four quality notations is accompanied by a scrolling 30-second graphical history, plus low and high values over the same period.



Here’s a rundown of the parameters shown: RSSI is received signal carrier strength in dBuV at the antenna input; RF SNR is a generalized signal/noise figure for the off-air RF signal, not an audio SNR measurement; Multipath is a relative readout of multipath (direct/reflected) distortion effects; and Blend indicates the degree to which the stereo program is ‘blended’ to mono for noise abatement, and is active only when that function is enabled under the Tuner menu. Signal quality measurements prove useful when setting-up a receive antenna.

Alarms

The SOFIA 565 offers alarm indications for various signal-related issues. Alarm status is displayed on the front panel, below the signal metrics readout here on the Now Playing Webpage, and on the Alarms Webpage where the alarm trigger and reset parameters are set. Alarm specifics and setup procedures begin on Page 22.

In addition to the alarm status indicators, the individual alarms can be assigned to rear-panel GPO terminals to tie into remote control systems, light accessory indicators, or sound a klaxon. GPO programming is explained on Page 26.

Alarms can also send email or SMS/text messages to specific personnel. Instructions for setting this up begin on Page 30.

Audio Program Metadata

The SOFIA 565 displays RDS/RBDS metadata associated with the audio program being monitored. All the major data fields are shown on the RDS Info page, but here on Now Playing you can see PI-Call: (PI code and call letters), the static or scrolling PS: (Program Service) field and RT: (RadioText) messaging.

Tuning the Radio

The SOFIA 565 is easily tuned from the front panel Tuner menu, or from the Tuner section of the Now Playing Webpage. Using the Web interface you can either directly overtype an FM frequency into the box to the right of Frequency (MHz);, or you can grab the slider knob and drag it back and forth. Or click on the slider knob and, once it's highlighted, use your keyboard arrow keys to move up and down the dial. The < > arrows on the screen also allow incremental tuning.

Station Presets

You may enter as many as 30 station-memory Preset Stations. Preset memories hold not only the tuner settings, but the independent alarm settings for each individual station as well.



To add a station to the Preset Stations list, tune to the station you wish to save and click on the Save as New bar. When you click on these presets to tune the radio, the selected station will display in yellow, per the example above. Delete any preset by clicking the **X** at the far right of the listing.

StationRotation™

The SOFIA 565 is capable of sequencing through all the saved Preset Stations entries in the order listed, and at a rate selected by the user. This might allow a contract engineer to receive alarms from any of a number of stations he might service in a given market.

NOTE: StationRotation operation will inhibit manual tuning! Front-panel station selection will be unavailable and the Web interface Tuner setup section will be grayed-out.

StationRotation must first be turned on by setting Enable: to On.

Next the Rotation Time (Sec): must be programmed. This takes some thought as there are alarm setup considerations when using this feature. Most alarms have time-on/time/off settings that will dictate the Rotation Time (Sec): setting. See the Alarms discussion beginning on Page 22.

The Status: display gives a second-by-second countdown of rotation time.

GRAPHS & METERING

Audio Level Metering

Near the top of this Web interface page you'll find an audio level metering utility with significantly greater resolution than the 10-segment front-panel LED or its on-screen counterpart that headlines every

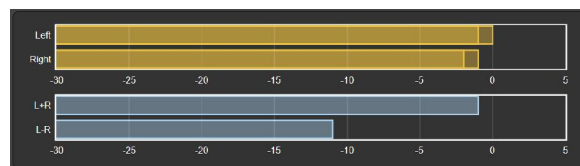

Web interface page. Levels for both the Left and Right channels

and the L+R/L-R stereo sum/difference are shown with linear-dB scaling.

The full-scale, 0dB point corresponds to 100% ($\pm 75\text{kHz}$) monaural analog-FM deviation. See Page 13 for other metering caveats.

Histograms

The next section on this Web interface page presents three ‘rolling histograms,’ or constantly-updated plots-over-time of important signal metrics.

The information shown here accumulates over the entire previous 24-hour period. The Time Span: setting below the graphs sets the time period displayed. Options are the last 1 Minute, the last 10 Minutes, the last 1

Hour, the last 6 Hours, or the entire previous 24 Hours. Click on these buttons to change the time period, or click anywhere in the display area to cycle through the options.

The upper graph shows Left and Right program channel levels over the selected time period. These levels reflect the unit’s peak-weighted metering, and although they do not represent r.m.s. ‘loudness’, one can get a pretty good idea of program audio dynamics (...or not!) from this display.

The lower graph plots signal metrics over time. The display defaults to a display of the three main parameters available, although the Show: buttons allow for selective presentation. The Y-axis resolution (level range) is optimized for the display as choices are reduced.

Obviously, the histograms represent only the station being received at the moment. If you change frequency to check on other stations in the market, the histograms will reflect parameters of those stations during your surfing expedition. You might want to jot-down the time away from the primary station target if the histograms will be analyzed after the fact.

The BandScanner™ Utility

The BandScanner utility of the SOFIA 565 is an annotated, simple RF spectrum analyzer. It can display the entire SOFIA 565 tuning range in two overlapping plots when Step Size: is set to the default 200kHz and an appropriate Center Frequency (MHz): chosen, as discussed below. Center Frequency (MHz): and Step Size: may also be programmed to zero-in on any narrow frequency range of interest.



NOTE: The band-scanning function mutes the receiver audio during the scan cycle and will put a glitch in the histograms as it actually tunes across the band and downloads data from each station in the market. This is another of the implications alluded-to earlier with respect to metering, histograms and FM band-surfing.

There are two scanning modes, or Scan Type: selections. The SOFIA 565 can scan the band and display only the RSSI level, which is the fastest scan, or it can scan and display both the RSSI + RDS information, which takes a bit longer.

Here is an FM-band plot of the Los Angeles market scanned in the RSSI + RDS mode. For this plot, Center Frequency (MHz): was set to **98.1**, with a Step Size: of **200kHz**. This puts FM station frequencies in the center of the screen. Alternatively, leaving Center Frequency (MHz): at the default value of **87.9** would skew this image to the right-hand margin and show activity down to 67.9MHz. A setting of 107.9 would skew it to the left, completely eliminating the display of frequencies below the present FM band.

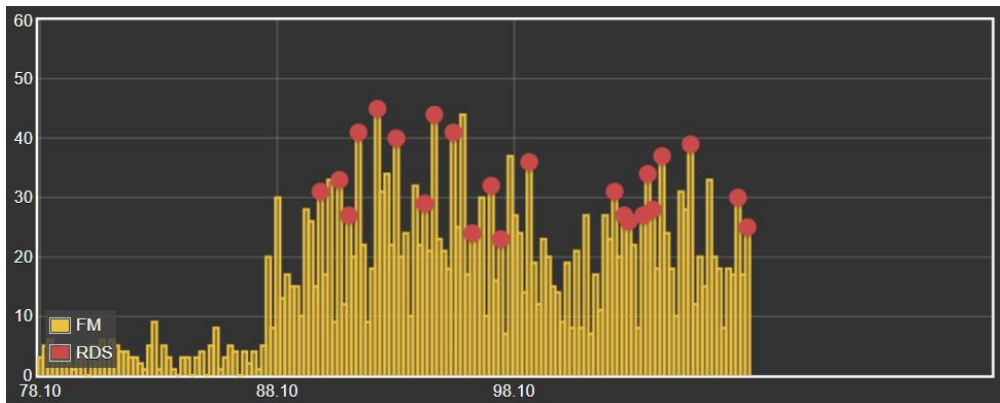

FM carriers are displayed as vertical bars, the height indicating the relative signal strength in dBuV per the annotation to the left of the plot. Had this scan been done in the simple RSSI: mode, all stations would show up just as yellow bars.

By 'hovering' over a yellow bar, the Freq: and RSSI: level are shown numerically in the pop-up per the first example on the right. Click on the bar and the radio will tune to that station and bring up the Now Playing page.

A yellow bar with a red dot indicates that the station carries RDS information. (The red dot shows only when the Scan Type: is set to RSSI + RDS.) Hovering over the red dot will show Freq: and RSSI:, plus the RDS PI: code and Call: letters (in the US and Canada), and the PTY, or programming format of the station as shown in the second example on the right.

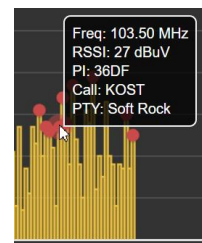
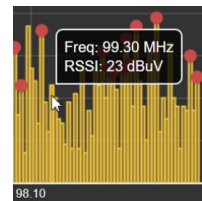

Market stations that carry RDS data are shown as RDS Stations: in the list directly below the scan. These are listed in ascending frequency along with their PI, callsign, PTY and RSSI values. Click on any station's frequency to immediately tune the SOFIA 565 to that station and be taken to the Now Playing Web interface page.

The 'Extended' FM Band

For the benefit of broadcasters in Japan or with European OIRT channel assignments, the SOFIA 565 tunes down to 64.0MHz. This would also accommodate a long-proposed-and-awaited expansion of North American FM broadcasting should it eventually come to pass.

The BandScanner utility is able to display a spectrum plot down to 64MHz, although it probably won't be of much interest to broadcasters in the western hemisphere. Again, with a Step Size: of **200kHz**, but with a Center Frequency (MHz) of **76.1**, here is a plot taken in the same the L.A. market:

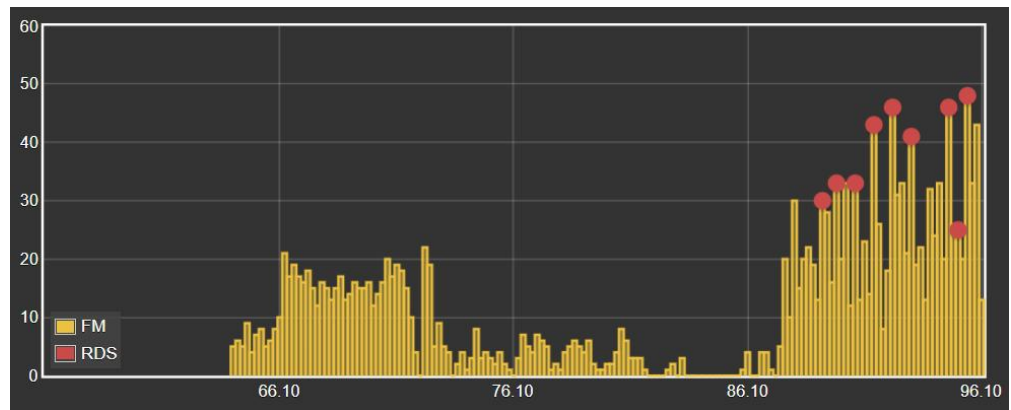

RDS INFO

As the menu title implies, this Web interface page is a comprehensive display of the RDS information accompanying analog-FM transmissions. It isn't within the scope of this manual to introduce, define and describe RDS features, data, formatting and grouping. For that the reader is directed to the appropriate Standard for either the European RDS or US RBDS RadioData housekeeping utility.

RDS Data Display

The top area of the screen shows the most important blocks of RDS data: the static or scrolling PS; the PI Code, either assigned or, in the US and Canada, derived from the Callsign; RadioText and its interactive RT+1 and RT+2 derivatives; plus the various IDs and 'flags' that assist RDS receivers in responding to system commands.

A bit down the page is an analysis of the RDS Block Error Rate, useful in troubleshooting RDS problems. You'll also find a statistical presentation of all RDS data 'groups,' including the percentage of the data load that each group carries.

If the station has an AF List, those Alternative Frequencies are totaled and displayed. Special Open Data Applications (ODA channels) are similarly totaled and identified.

Alternative Frequencies		Open Data Applications	
AF1	90.7	8A	0xCD46 (RDS-TMC)
AF2	98.5	11A	0x4BD7 (RadioText+)
AF3	93.7	13A	0xC3B0 (iTunes Tagging)

A Clear/Reset RDS command does indeed clear the registers and starts a new RDS data collection. Reset is automatic when the station is changed.

ALARMS

Alarm Status

The SOFIA 565 provides alarms for a total of 6 signal or program-related error conditions.

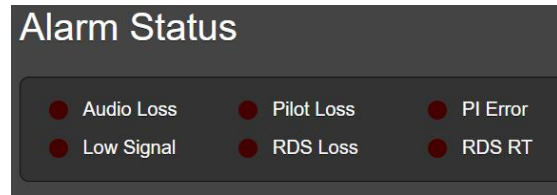

All six alarms give flashing notifications on the front-panel OLED screen, and are indicated in the Alarm Status area of this Web interface page as shown above. Any or all of the six are also able to initiate email or SMS/text messages to selected personnel, and alarms are logged for later analysis or finger-pointing.

Three major alarms are represented by LED indicators on the SOFIA 565 front panel, and up to four alarm conditions may be assigned to rear-panel GPO ‘tally’ outputs to interface with remote-control equipment or local lights and sirens.

Alarm conditions must first be set-up as described in the remainder of this section. Following that, the email/SMS messaging and rear-panel GPO tallies may be programmed. These procedures will be described in the Setup and Email Webpage discussions, respectively.

NOTE: Do please read the following discussions in their entirety. A setup explained for one alarm that is common (or quite similar) to the setup of others may not be repeated in full detail a second time.

Audio Loss

Alarm: On simply ‘arms’ the function for this and all similar instances. If the alarm is turned Off, there will be no front-panel AUDIO LOSS LED or corresponding indicator on the Web interface Now Playing or Alarm Web interface pages. There will be no closure at a rear-panel GPO terminal,

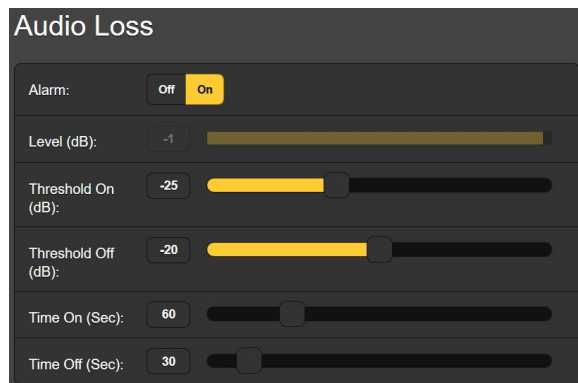

nor will the SOFIA 565 send SMS/text or Email alerts to station personnel or log the alarm. This applies to all alarms.

Level (dB): displays the audio metering level of the off-air program being received. This is 'grayed-out' because there is no adjustment to make in this case. The audio level is shown to make alarm setup easier.

Threshold On (dB): is the set point that the program must drop below to trigger an alarm. Moreover, the program level must remain below this set point for the number of seconds programmed by the **Time On (Sec):** slider. For the alarm to reset, the program level must re-attain a specified **Threshold Off (dB):** value and remain above that point for the number of seconds set by the **Time Off (Sec):** slider.

In this example, the program must fall below -25dB for a full 60 seconds to trigger an alarm. Then when the program returns, it must stay above -20dB for 30 seconds for the alarm to reset.

Low Signal

This alarm is similar to one just discussed for audio loss. When **Mute:** is turned On, program audio at all outputs is 'squelched' (silenced) during the alarm interval. With an FM receiver, this keeps 'interstation hiss' from making a nuisance of itself when the incoming signal is lost.

The **RSSI (dBuV):** grayed-out bargraph gives the level of the incoming RF carrier. **Threshold On (dBuV):** and **Threshold Off (dBuV):** set points are programmed in much the same manner as the audio-loss alarm example above.

RDS Alarm

There are two Off / On settings for RDS errors. Turning **RDS Loss: On** delivers an alarm when the RDS subcarrier simply goes missing. Setting **PI Error: On** gives an alarm when RDS is received with a PI code mismatch.

RDS data transmitted with an analog-FM broadcast contains a PI code unique to that station. A PI mismatch can signal a translator 'hijacking' by a radio hooligan, or the less sinister condition of the expected signal going off-air and a distant on-channel broadcast received in its place.

To enable the PI mismatch function, enter the station's true PI code in the **PI Code:** box. The code being received at the moment is shown as **Current PI:**. Simply enter that same hex value as shown and then click **Save**.

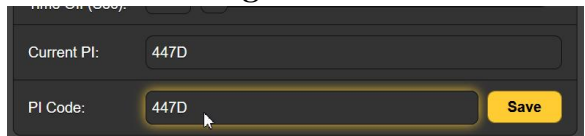

There are no threshold settings for RDS alarms, and both RDS loss and PI mismatch share the same **Time On (Sec):** and **Time Off (Sec):** settings, which work the same way as the alarms already discussed.

RT Update Not infrequently a station's playout system will 'stick' while sending RDS RadioText. RadioText is sent as a complete data message, unlike the static or scrolling PS field that is transmitted as a rapid succession of 8-character data blocks. This and other complexities (the associated RT+ features, for example) make the RadioText field more likely to cause problems than other RDS functions when it misses an update.

By turning the Alarm: for this function On, and setting a Time On (Min): at a nominal figure of 20 minutes or so, personnel will be alerted to a 'stuck' RadioText field when a RadioText update is not received during the specified period.

Pilot Loss This alarm indicates the loss of the FM stereo pilot, which could coincide with poor signal reception or a failure in the station's stereo generator.

Alarm Logging In addition to local displays and messaging alerts to signal and programming errors, the alarm data are logged and stored indefinitely. You can click on + View Alarm Log near the bottom of the page for a display of all alarms in chronological order.

The log holds data on the type of Alarm, which monitored Station it pertains to (important when the StationRotation feature is active), the Time and Date received, and its Duration.

You can View Alarm Log on your screen and even filter the results by overtyping Filter alarms... with a search term from the appropriate column.

You may also download the Alarm Logs for Daily, Weekly, Monthly or Complete (all logged alarms) time periods. The number of alarms received for these time periods is shown at the top. Downloads are saved to your computer as small .csv text files.

The Alarm Log will continue to accumulate entries, but you may clear it at any time by clicking the Clear Alarm Logs bar. This will delete all entries. You'll be asked to confirm this action, and you might decide to download the Complete log of all alarms first to be on the safe side.

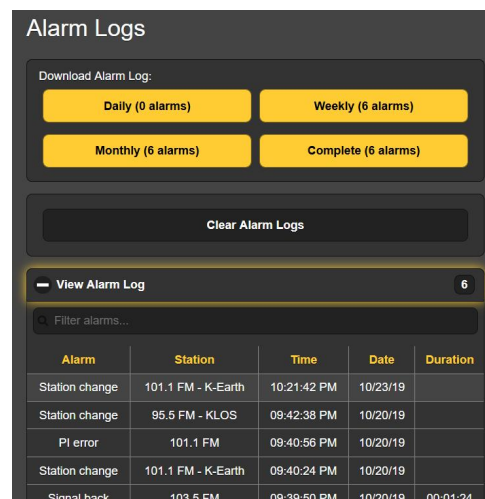

SETUP

This Web interface page is not as imposing as its name suggests, as SOFIA 565 setup is accomplished by entries on a number of the Web interface pages. The specific items on the Setup page are discussed in order here.

Radio Settings 75 μ s is the default De-Emphasis: setting common to the western hemisphere. This may be manually changed to 50 μ s, the standard for Europe and some other world regions. A proper setting is recommended, as the wrong one will upset the tonal balance of FM reception.

RDS/RBDS: sets the mode for RadioData between the European RDS or the North American RBDS standards. Although the two standards have become more-or-less ‘harmonized’ over the years, certain RDS features do still differ and will not behave appropriately with the wrong setting here. The RBDS default setting is common to North America.

Audio Outputs The levels for SOFIA 565 audio outputs are individually adjustable. Please note the associated comments relating to what these levels actually mean.

The Analog Level (dBu): slider sets the rear-panel XLR balanced left and right analog outputs to any dBu value between -15dBu and +15dBu. dBu signifies the *unloaded*, balanced level from these outputs, which have a source impedance of 200 ohms. This means that a 600-ohm-loaded dBm reading will be about 2.5dB lower than the figure shown. However, the concept of 600-ohm sources and terminations in professional audio practices date back to the days of transformer coupling, leased telephone lines and ‘repeat coils,’ and the notion of audio signal impedance matching is nowadays generally regarded as “old school,” clearly passé.

Also with regard to the analog output level, the dBu notations beside the slider actually refer to the *r.m.s. average* level of a sine-wave tone with a peak value corresponding to 100% FM carrier modulation (± 75 kHz monaural carrier deviation at 400Hz).

The Digital Level (dBFS): slider adjusts the rear-panel XLR AES3 digital program line output between -30dBFS and 0dBFS. Levels in this case are dBFS *peak* values at the output, again corresponding to ± 75 kHz mono-FM carrier deviation. An accepted and appropriate setting for this slider would be in the neighborhood of -12dBFS, allowing sufficient headroom for FM carrier overmodulation, acknowledging that the average off-air program level will usually be so uncomfortably close to the peak level as to eschew a more conservative headroom buffer.

In general, the Dante/AoIP Level (dBFS): requires the same considerations as the AES digital output and may be set similarly.

The Stream audio output references the Web-listening utility, which is independent of AoIP streaming. Web-listening relates to the little loudspeaker icon at the top of each SOFIA 565 Web interface page, which can be clicked-on by as many as 10 users at the same time who have Internet access to the unit.

The streaming Format: defaults to the popular MP3 standard, although it may be reset to OGG, a family of audio file types

that may enjoy a slight sonic advantage over MP3, in addition to being free from draconian licensing encumbrances.

The streaming Bitrate: defaults to 128kbps, generally judged as acceptable for all-but-very-critical radio listening. For unbelievably-poor network conditions the bitrate can be reduced all the way down to 32kbps, or for high-quality audio over a local LAN, up to 256kbps.

The stream Sample Rate: may also be changed, from the typical broadcast-plant default of 44100Hz to other sampling rates between 16kHz and 48kHz. Again, network limitations or specific installations may dictate this setting.

A unique and useful feature of the SOFIA 565 is the ability to purposely add-in a fixed Audio Latency (Sec): delay that may help overcome deficiencies of an uncertain network connection. Rather than allowing network latency to degrade packetized audio transmission, building-in an intentional delay of a few seconds gives the system time to reassemble the data with fewer errors, and with just those few seconds' temporal inconvenience.

As already stated, the SOFIA 565 can accommodate as many as 10 simultaneous Web listeners. This number can be truncated, however, in the interest of better streaming service to fewer authorized listeners. The Max Listeners: slider can be set between 0 and 10.

Once changed, Stream settings must be saved by clicking on the Save bar. Note that this does reset the utility, disconnecting any current listeners, who then must log back on.

General Purpose Outputs

The rear-panel GPOs serve as 'tally' outputs for SOFIA 565 alarms. The four associated rear-panel terminals give access to closures to (or opens from) ground for any four alarms selected from the field of five (plus None).

Each GPO is programmed separately. The Output # numbers on this Web interface page correspond to the four numbered terminals on the back of the unit. +5V and ground are also provided on the terminal strip.

In the example shown here, Output 1 has been Polarity:-programmed to deliver an Active Ground to GPO terminal 1 for an alarm Type: of Audio Loss. It could as easily have

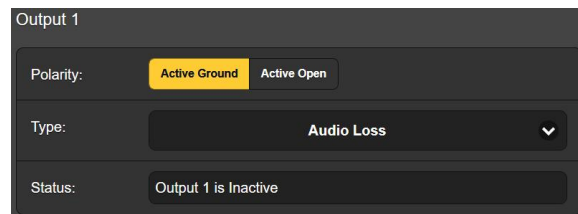

been set to deliver ground on that terminal all the time, and then go Active Open (ungrounded) when the alarm is received.

The Status: line in this example shows that Output 1 is Inactive; that is, the assigned Audio Loss alarm has not been tripped.

Any of the 5 listed alarm conditions could have been assigned here in the Type: field. Choose the four that are most important to you and assign them to the four GPOs.

The two RDS alarm conditions, RDS Loss and PI Error have been merged in this rear-panel 'tally' (GPO) utility. An RDS Error here will indicate either of the RDS fault conditions when they are turned On on the Alarms Web interface page.

NETWORK SETUP AND INTERNET ACCESS

Obviously, if Web interface pages are appearing on your screen, what follows here must already have been addressed. Getting up-and-running through front-panel setup was covered on Page 15, so most information here may turn out to be redundant.

IP Setup

With Mode: set to DHCP, your router automatically assigns the SOFIA 565 an IP Address: and will populate the four associated fields, although they will be 'grayed-out' and you'll not be able to edit the data in those fields. However, if Mode: is changed to Static IP, then you must make the appropriate entries in all four fields.

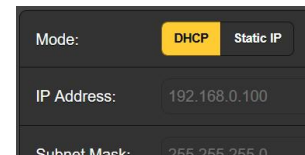

Assigning a Hostname

You may change the default name SOFIA565 to something else, either to personalize the equipment name or to differentiate one SiteStreamer+ from another on the same network.

Overtyping the default Hostname: using all-capital letters and without using spaces. Be sure to click the Save bar at the bottom once all entries are finalized. A changed Hostname will be seen at the top of all Web interface pages.



HTTP Port

The default HTTP Port: 80 is commonly used when accessing networked equipment like the SOFIA 565 on a local network (LAN). Provision is included to change this to another port number as may be required under certain circumstances. Remember to Save your new setting.

MAC Address

The MAC Address: (Machine Access Code) is the digital ID of your particular SOFIA 565. This is factory-assigned and cannot be changed. You may wish to make note of your unit's 'signature,' however, to help identify it on your network.

Link Speed

Link Speed: is an indication of connection status and the best expected bitrate between your SOFIA 565 and the local network (LAN).

Addressing the SOFIA 565

Under the Windows operating system, you can access the SOFIA 565 Web interface on a common LAN by just typing its Hostname and a forward-slash into the browser address bar as shown

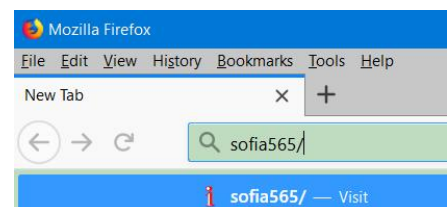

here. The entry is not case-sensitive in this instance. Non-Windows browsers may require you to enter the complete IP address of the unit, which you can always find by front-panel navigation to Setup / Network / IP Settings.

Incoming Internet Access

To ‘dial into’ the SOFIA 565 from the Internet, the unit must be assigned a static IP address. If your router makes DHCP assignments for other equipment on the network, simply assign a static IP that is outside the router’s DHCP range. This should be an easy matter with the aid of the router’s Help utility.

You also need to open a specific port for the SOFIA 565 on the network router. Within the router’s Port Forwarding utility you will be able to enter your static IP address for the unit (Internal IP), followed by a colon and a port number. The port number may be any number in the router’s range.

If your Internet Service Provider (ISP) assigns you a static IP address, then it is a simple matter to address the SOFIA 565 from anywhere. Just type the IP address and port number into your browser as pictured here.

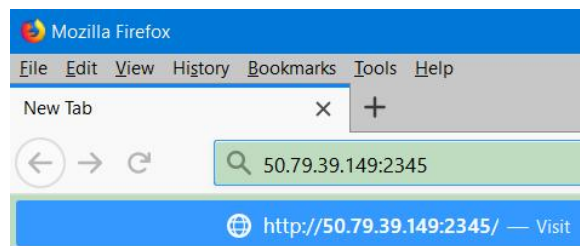

But if your ISP issues a *dynamic* IP, which is quite often the case, this mandates ‘Dynamic DNS’ operation using the services of an IP-forwarding provider. This is an operation you should entrust to your IT department, though explanations and instructions are available from multiple Web resources.

DANTE®

The term Dante® refers to networking technology developed by the Australian firm, Audinate Pty. Ltd. It enables simple connection with other Dante-equipped devices and gives AES67 AoIP (Audio over Internet Protocol) compliance and interoperability among a wide range of pro-AV products. Dante is generally also compatible with proprietary systems from independent manufacturers of AoIP-enabled products.

IP Settings Mode

The Dante-based AoIP utility of the SOFIA 565 is quite similar to the product’s general networking function. Like the LAN connection, the independent AoIP connection may accept IP address assignments in either a DHCP or Static IP assignment Mode:. Static IP operation requires manual entries into the four fields that are grayed-out when your router makes DHCP assignments.

AES67 and AoIP Streaming

The Dante utility of the SOFIA 565 is able to AoIP-stream audio at two sample rates. The “AES67 Standard” from the Audio Engineering Society specifies a 48kHz sample rate, but Dante en-

coding can send at a 44.1kHz rate as well, the more common rate in radio broadcasting. With AES67 Enable: set to Enabled, streaming is forced to a 48kHz sample rate.

**The AoIP
MAC Address**

The MAC address: for AoIP streaming is not the same as the one for general Web interactivity of the SOFIA 565. These are two independent network connections, and like the rear-panel LAN Port, the AoIP Port has a unique Mac Address: that is factory-assigned and cannot be changed.

Link Speed

Link Speed: this is a readout showing connection status and the expected best networking rate for the AoIP connection.

Audio Format

Encoding: refers to the word length for the PCM-encoded digital audio to be sent as AoIP. PCM 16 / PCM 24 / PCM 32 refers to word length for Dante AoIP flows. AES67 flows are locked to 24 bits regardless of this setting.

Sample Rate (Dante & AES3): is forced to 48kHz for AES67 streaming, or can be reset to 44.1kHz for other applications.

Transmit Flows

The AoIP utility can specify either one or two IP destinations for the audio stream. These are set in the Dante Controller.

This snapshot is typical of what you might see in the Transmit Flows area.

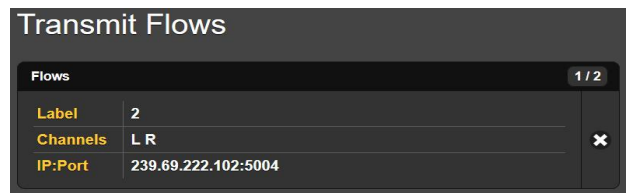

**The Dante
Controller**

The Dante Controller is a free software utility available from Dante's developer, Audinate. It is an essential software means of finding, setting-up and controlling Dante-enabled devices on your network. It may be downloaded for operation under either Windows or Macintosh operating systems using the following link:

<https://www.audinate.com/products/software/dante-controller>

SNMP OPERATION

SNMP (Simple Network Management Protocol) allows other TCP/UDP/IP equipment on the same Local Area Network (LAN) to communicate directly with your SOFIA 565, and for your unit to send alarms and supplementary information to other equipment on the network.

The SOFIA 565 will interface directly with a network controller, technically known as the SNMP 'Manager.' The SOFIA 565 has an embedded ASCII text file called a Management Information Base, or MIB. In setting up for SNMP operation, the MIB file will have to be downloaded from your unit through the Web interface and then uploaded to the SNMP Manager. This is detailed later-on.

- Mode** The SNMP submenu default Mode: setting is Disabled, which inhibits communication between the SOFIA 565 and the SNMP Manager.
- Changing Mode: to Read Only allows the SOFIA 565 to be interrogated by the SNMP Manager, so that programmed setup parameters, alarms, etc. can be integrated with other equipment on the network.
- Setting the Mode: to Read & Write allows the SNMP Manager to send commands that can control your SOFIA 565.
- Security** SNMP ‘Communities’ serve as passwords for this function. In the Read Community: and Write Community: fields, overtype the factory defaults and enter text that is specified for the read/write strings on the SNMP Manager monitoring device. You must do a Save after entering your text.
- Ports** The default SNMP Ports, SNMP Port: 161 and Trap Port: 162, are customary for a majority of SNMP operations. Overtyping these defaults to change them as required.
- Trap Destinations** When the SOFIA 565 *initiates* an alarm, rather than being *queried* or *polled* for one, the alarm is known as a ‘trap.’ Three local network IP addresses may be entered in the Trap Destination 1:, 2:, and 3: fields, each corresponding to other devices on the LAN that need to be apprised of alarms. Overtyping the defaults with valid IP addresses of other equipment.
- The MIB File** The MIB File is a small text file required by the SNMP Manager. Click: Download MIB to save this file using the usual Windows methods. The MIB file is in plain text with a .mib extension, and may be read with Windows Notepad.
- NOTE: This is an abbreviated discussion of SNMP operation. SNMP is a complex utility managed exclusively by whatever SNMP ‘Manager’ (monitoring equipment) is employed. Refer to all instructions supplied with, and for, the SNMP Manager hardware and/or software in setting-up the SOFIA 565.

EMAIL

- Email and Text Notifications** NOTE: The time-stamp feature for email notifications and the Alarm Log depends on a network connection to sync with Internet time, along with setting the proper time zone and other options. This is detailed on Page 32.
- When it’s connected to the Internet, the SOFIA 565 can send email or SMS/text notifications of reception or programming faults to one or more recipients. But which alarms go to whom is a separate setup routine; stay tuned.
- SMTP Setup** The SOFIA 565 must first be properly programmed to send mail under SMTP Settings. You need to set up an actual email account, the elements of which are just like setting up any con-

ventional email account. Information to be entered here depends on the provider you choose. When you apply for the account, much of this information will be assigned to you. Consult your IT professional for setting up email accounts if you need to.

Under SMTP Server:, enter the provided outgoing mail server info (e.g.: smtp.gmail.com), the required Port: number and whether TLS: is On or Off.

From: is the 'friendly' name that identifies the SOFIA 565 to the email or SMS/text recipient. You could use station call letters, or something like SOFIA Alarm or Oh NO! User: is the full email address of the unit. You may assign a Password: to the account.

**Recipients,
(Send To)**

Next enter up to ten email recipients, typing-in the full email address. After this you'll decide who gets what alert.

Email addresses typically take the form of the upper example here. If instead you wish to send a text message to a recipient's cell phone, the entry may look like the second image. In this instance the alarm notifications are being directed to a Verizon subscriber's phone.

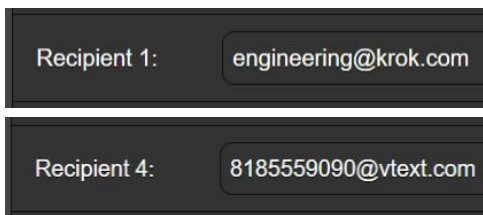

Further information on these naming protocols is available on the Web, or you can check with the wireless carrier to confirm the proper addressing style for Internet texting delivery.

When all recipients have been entered, click Save. You may also click Send Test Email, which will memo-message all recipients to confirm proper communications setup.

**Notifications,
(Send What)**

You can assign any or all alarms to any or all email or text addresses in the Notifications section.

Referring to the example here, choose a recipient 1 through 10 by clicking the down arrow. With a Recipient: selected, click the Send Emails For: boxes to choose which alarm conditions will be reported to that individual.

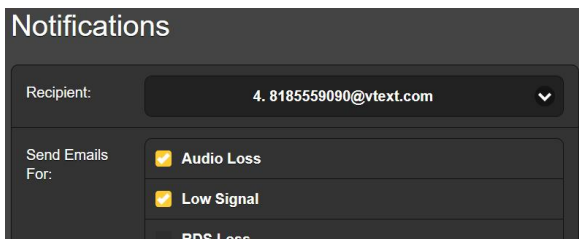

In this abbreviated example, the Chief Engineer will receive a text message on his phone for Audio Loss and Low Signal alarms. When you've finished with this Recipient, proceed to the next. A Save command is not necessary in this operation.

TIME SETUP

Time and DST

The onboard Real Time Clock will receive updates from Internet Time daily and has sufficient inherent precision to remain accurate inside this schedule. Grab and drag the Time Zone

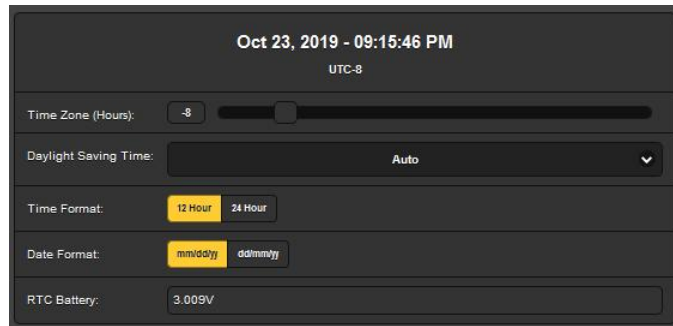

(Hours): slider for the proper offset from Universal Coordinated Time for your area. In this example, the -8 represents West Coast US (Pacific) time. The time at the top of the page will update immediately, so you can simply drag the slider until the time shown here agrees with that big clock on the wall.

Daylight Saving Time: is set to the default Auto mode in this example. You may either opt for this convenience, or click the down arrow to select On or Off for DST.

Presentation Formats

Time Format: can show either a 12 Hour or a 24 Hour clock, and the Date Format: can reflect either US or European conventions. The date is automatically set by the Internet Time Server.

RTC Battery

The Real Time Clock has a backup battery located on the rear of the front-panel board. This is a 3V CR2032 flat 'coin cell' battery with the + side facing out. Replace the battery when RTC Battery: voltage drops to 2V.

Time Server

We have provided a reliable default time server, which is 1.inovonics.pool.org. If you must change the server because of some corporate edict, overtype the Server: entry with your alternate and click Save.

ADMINISTRATIVE MATTERS

Security and Passwords

SOFIA 565 access may be protected by passwords, which must then be entered before any changes can be made. Either the same or separate passwords may be assigned to lock out the front-panel jog wheel and/or Web interface access.

Under the Security heading, enter the Front Panel: and Webpages: fields to type-in a password for limiting access to either or both avenues of approach. Click Save to lock passwords into non-volatile memory.

NOTE: Passwords will appear in clear text on both the front panel OLED and Web interface screens, but of course only trusted and authorized, logged-in users will be able to see those screens.

Once the password is saved, no Web interface screen is accessible. The front-panel Now Playing screen will be the only one visible.

With respect to front-panel access, the SOFIA 565 will lock any time the screen times-out (goes dim or dark) after the unit is untouched for the programmed-in timeout period. The unit may be locked immediately by holding down the Back button for a few seconds.

Signing In

With password protection in place, at the installation site you will be prompted to enter the password through the front-panel OLED screen and jog knob before any menu can be accessed other than Now Playing. Use the knob to spell-out the password, and then highlight Save and push the knob. This will be necessary each time the unit times out to a dark or dim screen.

When working on a protected unit over an extended period, you can avoid the frustration of having to keep re-entering a password from the front panel by resetting the Admin / Display / Timeout setting to 60 min. From the Admin / Security screen you could also repeatedly push Del to delete the password, but of course jot it down first so you can put it back in when finished.

The Web interface password must be entered on any connecting device. When this image appears on your screen, ignore User Name: and enter the password into the Password: field, then click OK.

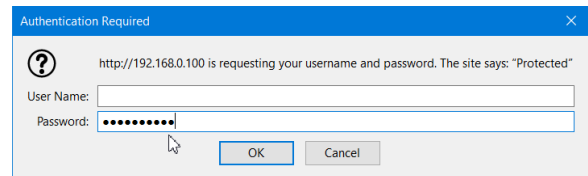

Lost Password (Hard Reset)

NOTE: A 'hard reset' is required to bypass a local or a Web interface password. *This must be done at the installation site!* A hard reset not only deletes the password, but will also return the SOFIA 565 to all-factory-default settings. *All User settings will be lost!* This illustrates the importance of keeping a Hardware Profile current, which is discussed next.

If the password is lost, the only way you can recover control of the SOFIA 565 is from the equipment site. Hold down the Back button as you power-cycle the unit (disconnect and then reconnect AC-mains power).

The Hardware Profile

The entire SOFIA 565 'setup' may be saved to your computer as a small text file. The Hardware Profile includes user settings, alarm notification entries, SNMP options, etc., and is useful for restoring a previous setup or for cloning a second unit for backup service.

To save a profile to your computer, under Configuration click: Download Hardware Profile. With the Firefox browser used in this example, Windows first asks whether to Open or Save the file. After clicking the Save button and OK, Windows

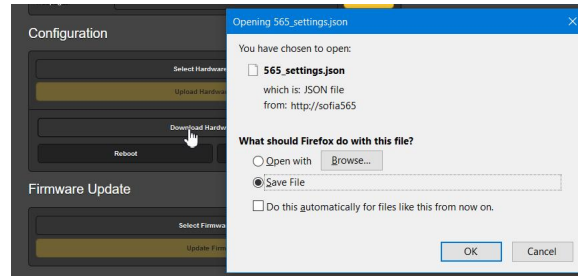

saves the file to the browser's assigned 'Save' location, usually the Windows Downloads folder. From there you can move it to a folder of your choice. The file carries a default name of 565_settings.json.

To upload (restore) a saved setting, first click Select Hardware Profile..., navigate to the folder where the profile has been saved and, when prompted, Open the file. Then click Upload Hardware Profile. This will replace all set-up parameters currently loaded and running in your SOFIA 565 with the saved ones.

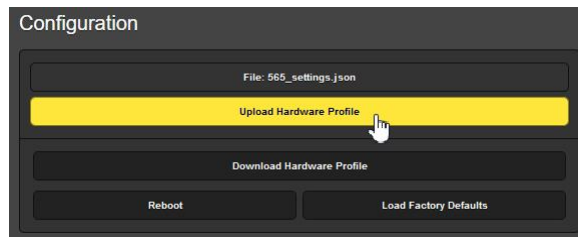

Reboot Uploading a Hardware Profile automatically reboots the SOFIA 565. There may be other circumstances under which you might want to reboot the unit manually. This can be done by clicking Reboot in the Configuration area.

A *manual* reboot does not change any settings or dump any accumulated off-air data, it's simply the same as doing a local power cycle. The SOFIA 565 will come back tuned to the same station and with all settings intact.

However, at any time you wish to 'clean house' and restore all settings and preferences to factory values, click: Load Factory Defaults. In this case you *will* lose your settings, except for IP settings (to maintain access to the unit), so doing a Hardware Profile download first might be a good idea.

Updating Firmware SOFIA 565 firmware includes the Web interface pages, and updates are easily uploaded to the unit when issued by Inovonics.

NOTE: We recommend saving a fresh Hardware Profile, as a firmware update may affect user settings. If there is danger of compromising stored data, the firmware update will include notes to that effect.

Updates are issued as small .bin files which may be downloaded to your computer Desktop or placed in any convenient folder. From the Firmware Update utility at the bottom of the Admin screen, click Select Firmware File... and double-click the .bin file listing. This will transfer the file to the updater as shown at the top of the next page.

With the name of the new .bin showing in File:, click Update Firmware and follow the prompts to complete the process. Updating takes a couple of minutes and will return you to the new Web interface pages once the operation is complete.

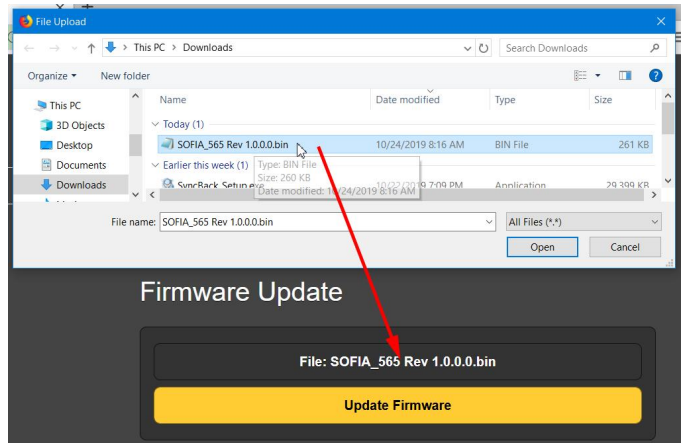

'About' Info

The bottom of the Admin screen shows the Serial Number: of your SOFIA 565 encoder, gives the current Firmware Rev: and displays the Uptime:, or how long your SOFIA 565 has been running since power was last applied. You also may click Check for Updates to see if a new version of the firmware has been issued.



INOVONICS WARRANTY

- I **TERMS OF SALE:** Inovonics products are sold with an understanding of “full satisfaction”; that is, full credit or refund will be issued for products sold as new if returned to the point of purchase within 30 days following their receipt, provided that they are returned complete and in an “as received” condition.
- II **CONDITIONS OF WARRANTY:** The following terms apply unless amended *in writing* by Inovonics, Inc.
- A. Register the Warranty online at www.inovonicsbroadcast.com within 10 days of delivery.
 - B. This Warranty applies only to products sold “as new.” It is extended only to the original end-user and may not be transferred or assigned without prior written approval by Inovonics.
 - C. This Warranty does not apply to damage caused by misuse, abuse, accident or neglect. This Warranty is voided by unauthorized attempts at repair or modification, or if the serial identification label has been removed or altered.
- III **TERMS OF WARRANTY:** Inovonics, Inc. products are warranted to be free from defects in materials and workmanship.
- A. Any discrepancies noted within THREE YEARS of the date of delivery will be repaired free of charge, or will be replaced with a new or remanufactured product at Inovonics’ option.
 - B. Parts and labor for factory repair required after the three-year Warranty period will be billed at prevailing prices and rates.
- IV **RETURNING GOODS FOR FACTORY REPAIR:**
- A. Equipment will not be accepted for Warranty or other repair without a Return Authorization (RA) number issued by Inovonics prior to its return. An RA number may be obtained by calling the factory. The number should be prominently marked on the outside of the shipping carton.
 - B. Equipment must be shipped prepaid to Inovonics. Shipping charges will be reimbursed for valid Warranty claims. Damage sustained as a result of improper packing for return to the factory is not covered under terms of the Warranty and may occasion additional charges.

